

Low-Rise Scissor Lift

Installation and Operation Manual

Manual P/N 5900075 — Manual Revision A1 — April 2019

Models:

- LR-10000



Designed and engineered by BendPak Inc. in Southern California, USA. Made in China.

 **DANGER**

Read the *entire contents* of this manual *before* using this product. Failure to follow the instructions and safety precautions in this manual can result in serious injury or death. Make sure all other operators also read this manual. Keep the manual near the product for future reference. By proceeding with setup and operation, you agree that you fully understand the contents of this manual.

Manual. LR-10000 Low-Rise Scissor Lift, *Installation and Operation Manual*, Manual Part Number 5900075, Manual Revision A1, released April 2019.

Copyright. Copyright © 2019 by BendPak Inc. All rights reserved. You may make copies of this document if you agree that: you will give full attribution to BendPak Inc., you will not make changes to the content, you do not gain any rights to this content, and you will not use the copies for commercial purposes.

Trademarks. BendPak and the BendPak logo are registered trademarks of BendPak Inc. All other company, product, and service names are used for identification only. All trademarks and registered trademarks mentioned in this manual are the property of their respective owners.

Limitations. Every effort has been made to ensure complete and accurate instructions are included in this manual. However, product updates, revisions, and/or changes may have occurred since this manual was published. BendPak reserves the right to change any information in this manual without incurring any obligation for equipment previously or subsequently sold. BendPak is not responsible for typographical errors in this manual. You can always find the latest version of the **manual for your product on the BendPak website**.

Warranty. The BendPak warranty is more than a commitment to you: it is also a commitment to the value of your new product. Contact your nearest BendPak dealer or visit www.bendpak.com/support/warranty for full warranty details. Go to bendpak.com/support/register-your-product/ and fill out the online form to register your product (be sure to click **Submit**).

Safety. Your product was designed and manufactured with safety in mind. However, your safety also depends on proper training and thoughtful operation. Do not install, operate, maintain, or repair the unit without reading and understanding this manual and the labels on the unit; **do not use your Lift unless you can do so safely!**

Owner Responsibility. In order to ensure operator safety and maintain your product properly, it is the responsibility of the product owner to read and follow these instructions:

- Follow all setup, operation, and maintenance instructions.
- Make sure product setup and use conforms to all applicable local, state, and federal codes, rules, and regulations, such as state and federal OSHA regulations and electrical codes.
- Read and follow all safety instructions. Keep them readily available for operators.
- Make sure all operators are properly trained, know how to safely operate the unit, and are properly supervised.
- Do not operate the product until you are certain all parts are in place and operating correctly.
- Carefully inspect the product on a regular basis and perform all maintenance as specified.
- Service and maintain the unit only with approved replacement parts.
- Keep all instructions permanently with the product and make sure all labels are clean and visible.
- **Only use the Lift if it can be used safely!**

Unit Information. Enter the Model Number, Serial Number, and the Date of Manufacture from the label on your unit. This information is required for part or warranty issues.

Model: _____

Serial: _____

Date of Manufacture: _____



BP BendPak		Santa Paula, CA USA www.bendpak.com	
MODEL NUMBER			
DESCRIPTION			
LIFT CAPACITY		DATE OF MFG.	
VOLTAGE		SERIAL NUMBER	
<input type="checkbox"/> 110-240V, 50-60 Hz, 1 Ph			
<input type="checkbox"/> 208-240V, 50-60 Hz, 1 Ph			
<input type="checkbox"/> 380-415V, 50-60 Hz, 3 Ph			
<input type="checkbox"/> 208-440V, 50-60 Hz, 3 Ph			
		UPC	
		DANGER! Disconnect Power Before Servicing	
		WARRANTY VOID IF DATA PLATE IS REMOVED PN 5905951	
			

Table of Contents

Introduction	3	Operation	30
Shipping Information	4	Maintenance	34
Safety Considerations	4	Troubleshooting	35
Components	6	Wiring Diagram	36
FAQs	7	Labels	37
Specifications	8	Parts Diagrams	39
Installation Checklist	10	ALI Store	42
Installation	11	Maintenance Log	43

Introduction

This Manual describes the LR-10000, which is low-rise, frame-engaging Lift designed and engineered for fast and easy wheel service. It is the perfect Lift for trucks and SUVs that many other Lifts cannot handle.

The LR-10000 can raise Vehicles up to 10,000 lbs (4,536 kg).

The LR-10000 is ALI certified. Search **Lift Type: Low/Mid Rise Frame Engaging Lifts** and **Participant: BendPak, Inc.** on autolift.org.

More information about the full line of BendPak products is available at bendpak.com.

This manual is mandatory reading for all LR-10000 users, including anyone who sets up, operates, maintains, or repairs it.

 **DANGER** Be very careful when setting up, operating, maintaining, or repairing this equipment; failure to do so could result in property damage, product damage, injury, or (in very rare cases) death. Make sure only authorized personnel operate this equipment. All repairs must be performed by an authorized technician. Do not make modifications to the unit; this voids the warranty and increases the chances of injury or property damage. Make sure to read and follow the instructions on the labels on the unit.

Keep this manual on or near the equipment so that anyone who uses or services it can read it.

If you are having issues, refer to the **Troubleshooting** section of this manual for assistance.

Technical support and service is available from your dealer, on the Web at bendpak.com/support, by email at techsupport@bendpak.com, or by phone at **(800) 253-2363**, extension 196.

You may also contact BendPak for parts replacement information (please have the model and serial number of your unit available) at **(800) 253-2363**, extension 191.

Shipping Information

Your equipment was carefully checked before shipping. Nevertheless, you should thoroughly inspect the shipment **before** you sign to acknowledge that you received it.

When you sign the bill of lading, it tells the carrier that the items on the invoice were received in good condition. **Do not sign the bill of lading until after you have inspected the shipment.** If any of the items listed on the bill of lading are missing or damaged, do not accept the shipment until the carrier makes a notation on the bill of lading that lists the missing and/or damaged goods.

If you discover missing or damaged goods **after** you receive the shipment and have signed the bill of lading, notify the carrier at once and request the carrier to make an inspection. If the carrier will not make an inspection, prepare a signed statement to the effect that you have notified the carrier (on a specific date) and that the carrier has failed to comply with your request.

It is difficult to collect for loss or damage after you have given the carrier a signed bill of lading. If this happens to you, file a claim with the carrier promptly. Support your claim with copies of the bill of lading, freight bill, invoice, and photographs. Our willingness to assist in helping you process your claim does not make us responsible for collection of claims or replacement of lost or damaged materials.

Safety Considerations

Read this manual carefully before using your new product. Do not set up or operate the product until you are familiar with all operating instructions and warnings. Do not allow anyone else to operate the product until they are also familiar with all operating instructions and warnings.

General Safety Information

- The product is a low-rise scissor Lift. Use it only for its intended purpose. Do not make any modifications to the product.
- The product must only be operated by authorized personnel.
- When the Lift is in motion, everyone except the Operator must be a minimum of 30 feet away.
- Wear appropriate protective clothing when installing, servicing, or repairing your Lift.
- Keep loads centered and balanced on the Platforms.
- When the product is in use, keep all body parts away from it.
- Make sure all Operators read and understand the *Installation and Operation Manual*. Keep the Manual near the device at all times.
- Make a visual inspection of the product before using it. Check for damage or missing parts. Do not use the product if you find any issues. Instead, take it out of service, then contact your dealer, email techsupport@bendpak.com, visit bendpak.com/support, or call **(800) 253-2363**.
- Make a thorough inspection of the product at least once a year. Replace any damaged or severely worn parts, decals, or warning labels.
- BendPak recommends referring to the ANSI/ALI ALIS Standard (R2015) *Safety Requirements for Installation and Service* for more information about safely installing, using, and servicing your Lift.

Symbols

Following are the symbols used in this manual:



DANGER Calls attention to an immediate hazard that **will** result in injury or death.



WARNING Calls attention to a hazard or unsafe practice that **could** result in injury or death.



CAUTION Calls attention to a hazard or unsafe practice that could result in minor personal injury, product, or property damage.

NOTICE

Calls attention to a situation that, if not avoided, could result in product or property damage.



Tip

Calls attention to information that can help you use your product better.

Liability Information

BendPak Inc. assumes **no** liability for damages resulting from:

- Use of the product for purposes other than those described in this manual.
- Modifications to the equipment without prior, written permission from BendPak Inc.
- Damage to the equipment from external influences.
- Incorrect operation of the equipment.

Components

LR-10000 components include:

- **Power Unit.** Provides Hydraulic Fluid to the Hydraulic Cylinders, which they use to raise the Platforms. Connects to an external electric power source.
- **Power Unit Stand.** Holds the Power Unit.
- **Short Ramps.** Used to drive Vehicles onto or off of the Platforms.
- **Hinged Ramps.** Hinges up when the Platforms are raised. Located on the other end of the Lift from the Short Ramps. Can also be used to drive Vehicles onto or off of the Platforms.
- **Platforms.** Flat steel plates that raise and lower. The Lift Pads or Lift Pad Extensions, which sit on the Platforms, make contact with the underside of the Vehicle to raise and lower the Vehicle.
- **Base.** The bottom of the Lift, everything around the Platforms.
- **Trays.** Built in to the Bases of the Lift, the Trays hold whatever you need them to hold.
- **Hydraulic Cylinders.** Push the Platforms up to raise a Vehicle, move down to lower a Vehicle.
- **Safety Locks.** Hold the Platforms in place while they are raised. The LR-10000 has three Safety Lock positions, which lets you select the right Platform height for your needs.
- **Safety Lock Release Handle.** Moves the Platforms off the Safety Locks when you want to lower the Lift.
- **Lift Pads and Lift Pad Extensions.** Blocks that make contact with the lifting points on the Vehicle being raised. You can stack one Lift Pad Extension on one Lift Pad, but no more than that.

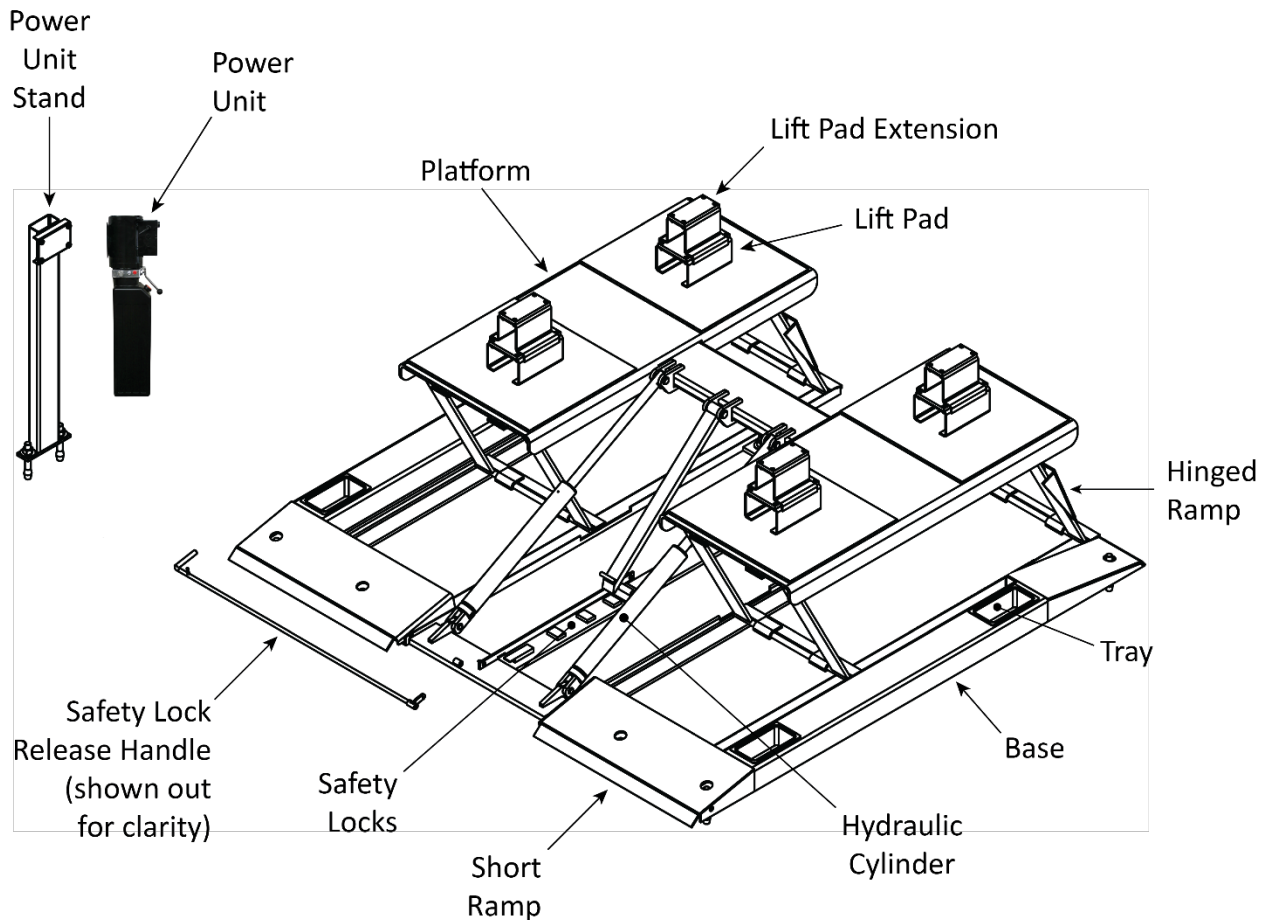

Frequently Asked Questions

Question: How much weight can the LR-10000 raise?

Answer: The LR-10000 can raise Vehicles up to 10,000 pounds (4,536 kg).

Q: Can the LR-10000 be installed outside?

A: No. The LR-10000 is approved for indoor installation and use only. ***Outdoor installation is prohibited.***

Q: Can I put the Power Unit Stand on either side of the LR-10000?

A: Yes. The Power Unit Stand can be located on either side of the Lift. The drawing on the previous page shows the Power Unit Stand on the left if you are looking at the Short Ramp end of the Lift. Note that the Safety Lock Release Handle ***cannot*** be moved to the other side. It can only be installed and used on the left side of the Lift if you are looking at the Short Ramp end.

Q: How far can the Power Unit Stand be from the closest side of the Lift?

A: If you want the Power Unit Stand on the left side of the Lift (looking at it from the Short Ramp end), it can be installed up to 77 inches / 1,956 mm from the side of the Lift. If you want the Power Unit on the right side of the Lift, it can be installed up to 53 inches / 1,346 mm from the side of the Lift.

Q: What if I want to raise a Vehicle that is slightly over the weight capacity of the Lift?

A: This is not an intended use of the product. We strongly recommend against trying to raise a Vehicle that is heavier than the rated capacity.

Q: How many locking positions does my Lift have?

A: Three. This gives you multiple heights to which you can raise the Lift, so it is easy to find the right height for the work you are doing.

Q: What do the Safety Locks do?

A: Safety Locks use gravity to hold the Platforms up, once they are *engaged*. Even if the Lift loses power, the Platforms stay where they are if they were left *engaged* on a Safety Lock. ***Only leave your Lift either fully lowered or engaged on a Safety Lock!***

Q: Which end of the LR-10000 is the “front”?

A: Neither. You can drive onto the Lift from either direction; there are ramps on both ends.

Q: The LR-10000 is described as “frame-engaging”, what does that mean?

A: It means the Platforms (actually, the Lift Pad or Lift Extensions on the Platforms) contact the underside of the Vehicle to raise it, leaving the wheels free. Put another way, the Vehicle is ***not*** raised on its wheels, like a Vehicle on a four-post Lift.

Q: Anything else I should be aware of?

A: One thing. Do not remove all four of a Vehicle’s tires while it is on the LR-10000 and then lower the Vehicle all the way to the ground. It will go down, but it will have a hard time coming back up again. The Lift requires some space to build up enough upward force to raise a Vehicle.

Specifications

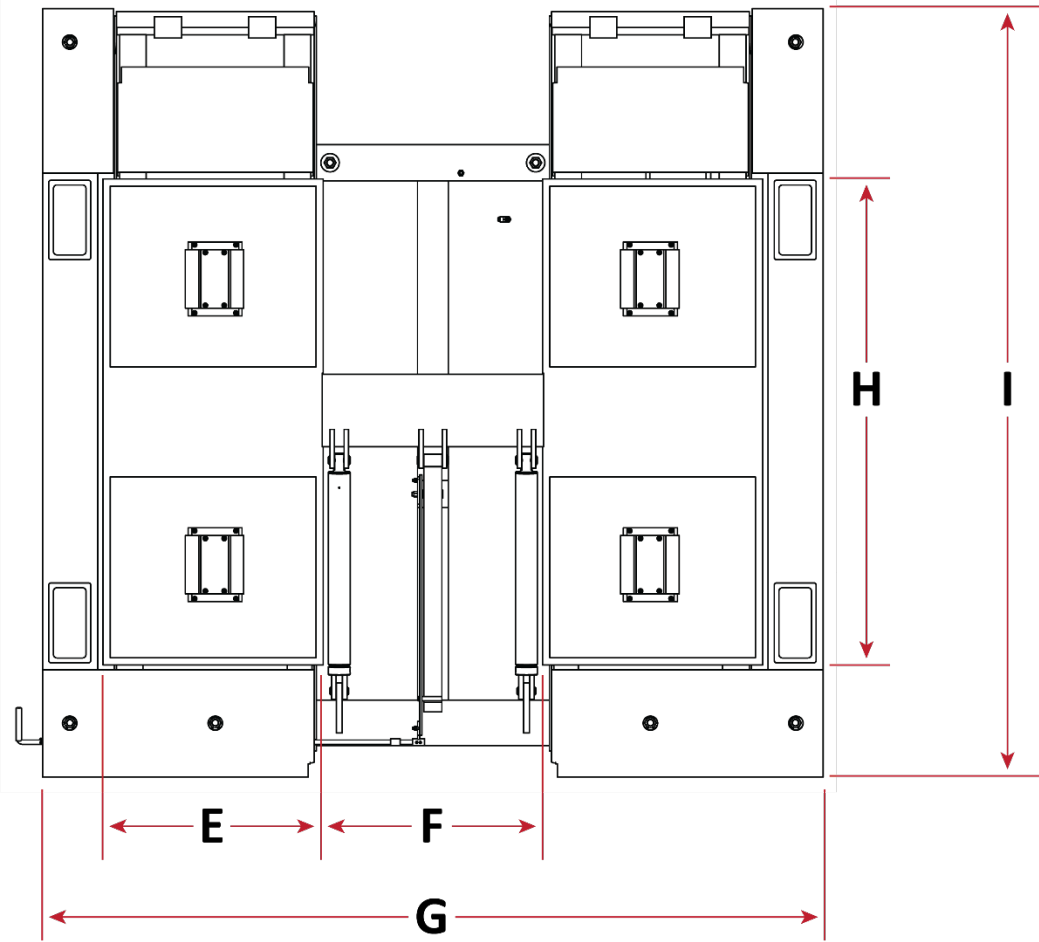
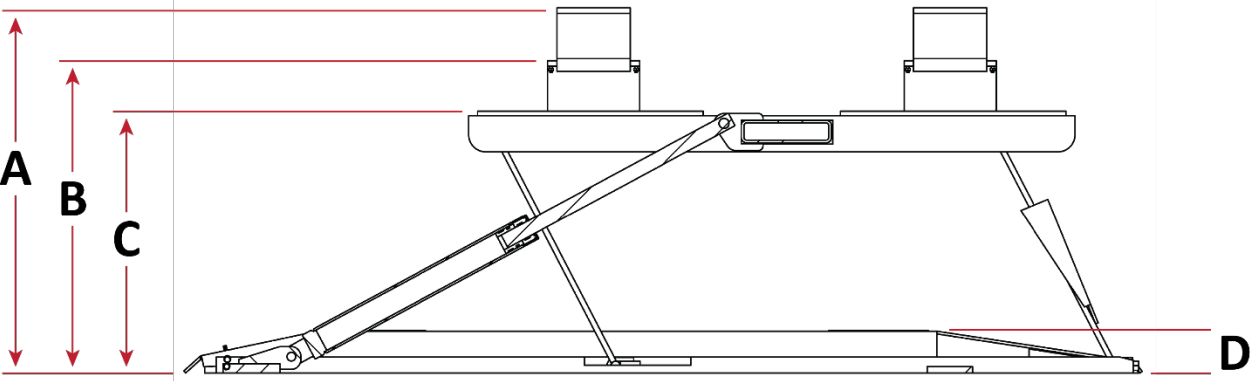

Model	LR-10000
Lifting capacity	10,000 lbs. / 4,536 kg
A Lift height w/Lift Pad and Extension	31.75" / 808 mm
B Lift height w/Lift Pad	27.25" / 692 mm
C Lift height	22.75" / 580 mm
D Lowered height	4.35" / 111 mm
E Platform width	24" / 610 mm
F Width between platforms	24" / 608 mm
G Overall width	85" / 2,162 mm
H Platform length	53" / 1,344 mm
I Overall length	83.5" / 2,124 mm
Maximum hydraulic pressure	2,650 PSI
Lifting time	~35 seconds
Motor	208 – 240 VAC, 50/60 Hz, 1 Ph

Specifications subject to change without notice.

Installation Checklist

Following are the steps needed to install your LR-10000 Lift. Perform them in the order shown.

- 1. Review the installation Safety Rules.
- 2. Plan for Electrical Work.
- 3. Make sure you have the necessary Tools.
- 4. Select the Installation Site.
- 5. Make sure there is adequate Clearance on all sides of the Lift.
- 6. Create Chalk Line Guides.
- 7. Anchor the Bases.
- 8. Install the Safety Lock Release Handle.
- 9. Set up the Power Unit Stand.
- 10. Attach the Power Unit.
- 11. Connect the Hydraulic Lines.
- 12. Prepare the Power Unit.
- 13. Install a Power Disconnect Switch.
- 14. Install a Thermal Disconnect Switch.
- 15. Test the Lift.
- 16. Review the Final Checklist.
- 17. Leave the Manual for the owner/operator.

Installation

This section describes how to install your LR-10000. Perform the steps in the order listed.

⚠ WARNING **Only use the factory-supplied parts that came with your Lift.** If you use parts from a different source, you void your warranty and compromise the safety of everyone who installs or uses the Lift. If you are missing parts, visit bendpak.com/support or call **(800) 253-2363**, extension 191.

The LR-10000 is supplied with installation instructions and concrete fasteners that meet the criteria set by the American National Standard “Automotive Lifts – Safety Requirements for Construction, Testing, and Validation” ANSI/ALI ALCTV-2011.

Lift buyers are responsible for regional, structural, and/or seismic anchoring requirements specified by any other agencies or codes, such as the Uniform Building Code or International Building Code.

Safety Rules

When installing the Lift, your safety depends on proper training and thoughtful operation.

⚠ WARNING Do not install this equipment unless you have automotive Lift installation training. Always use proper tools, such as a forklift or crane, to move heavy components. Do not install this equipment without reading and understanding this Manual and the safety labels on the unit.

BendPak recommends referring to the ANSI/ALI ALIS Standard (R2015) *Safety Requirements for Installation and Service* for more information about safely installing, using, and servicing your Lift.

Only fully trained personnel should be involved in installing this equipment. **Pay attention at all times.** Use appropriate tools and equipment, when needed. Stay clear of moving parts.

⚠ WARNING You must wear protective equipment at all times during the installation: leather gloves, steel-toed work boots, eye protection, back belts, and hearing protection.

Electrical Work

You will need to have a licensed, certified Electrician available at some point during the installation.

⚠ DANGER All wiring **must** be performed by a licensed, certified Electrician.

The Electrician needs to:

- **Connect the 208 – 240 VAC power source to the Power Unit.** This is generally done near the end of the installation. Note that installing the Power Unit and connecting the Power Unit are separate procedures; they are done at different times in the installation process. The Electrician will need to provide a power cord and a Plug and connect them to the Power Unit.
- **Install a Power Disconnect Switch.** A Power Disconnect Switch gives you a way to shut down the Lift in the event of an electrical circuit fault or emergency situation. Refer to [Install a Power Disconnect Switch](#) for more information.
- **Install a Thermal Disconnect Switch.** A Thermal Disconnect Switch automatically shuts down the Lift in the event of an overload or an overheated motor. Refer to [Install a Thermal Disconnect Switch](#) for more information.

Tools

You may need some or all of the following tools:

- Rotary hammer drill or similar
- 3/4", 3/8", 1 1/4" masonry bits
- Hammer
- Open-end wrench set: 1/2", 15/16" – 1 1/8"
- Socket and ratchet set, 1 1/8"
- Medium crescent wrench
- Chalk line
- Medium flat screwdriver
- Tape measure
- Forklift or Shop Crane

Select a Site

Keep the following in mind when selecting a site for your Lift:

- **Enough space.** Make sure there is adequate space on all sides, plus enough space above for the Vehicles you will be raising. See **Clearance Around the Lift** for more information.
- **Power Unit Stand.** The Power Unit Stand can go on either side of the Lift. The Safety Lock Release Handle, however, can only go on the left of the Lift (looking at the Short Ramp end).
- **Radial Shift.** When you raise the Lift, the geometry of the scissor arms moves the Platforms up at an angle, towards the Hinged Ramp end of the Lift. The amount of radial shift for the LR-10000 is approximately 12 inches. Note that radial shift is always the same direction, towards the Hinged Ramp end of the Lift, no matter which way the Vehicle is facing.
- **Check for overhead obstructions.** The site must be free of overhead obstructions.
- **Concrete specifications.** Do not install the Lift on cracked or defective concrete. Make sure the concrete is at least 4.25 inches thick, 3,000 psi, and cured for at least 28 days (if newly poured). Make sure the floor is defect-free, dry, and level.

 **WARNING** Do not install the Lift on a surface with 3° of slope or more. A 3° degree or greater slope makes the Lift less secure, possibly causing Vehicles to fall, which could lead to property damage, personal injury, or even death.

- **Power.** You will need a 208 – 240 VAC power source available near the Power Unit Stand. Use a 25 amp or greater fuse for a 208 – 240 VAC, 1 phase circuit.
- **Operating temperature.** The Lift is designed to be used between temperatures of 41° to 104°F (5° to 40°C).
- **Outdoor installation.** The Lift **cannot** be installed outside. It is for indoor use only.
- **Second floor installs.** Do not install the Lift on a second floor or elevated floor without first consulting the building architect and getting their permission.
- **Dress properly.** Always wear protective gear (like safety goggles, helmet, heavy gloves, suitable working clothes, safety boots, ear protection, and so on) when installing the Lift.

Do not wear loose clothing or jewelry; contain long hair; keep hair, clothing, and gloves away from moving parts.

 **WARNING** Always wear appropriate protective gear when installing the Lift.

Clearance Around the Lift

For safety purposes, a reasonable amount of clear space around the Lift is **required**.

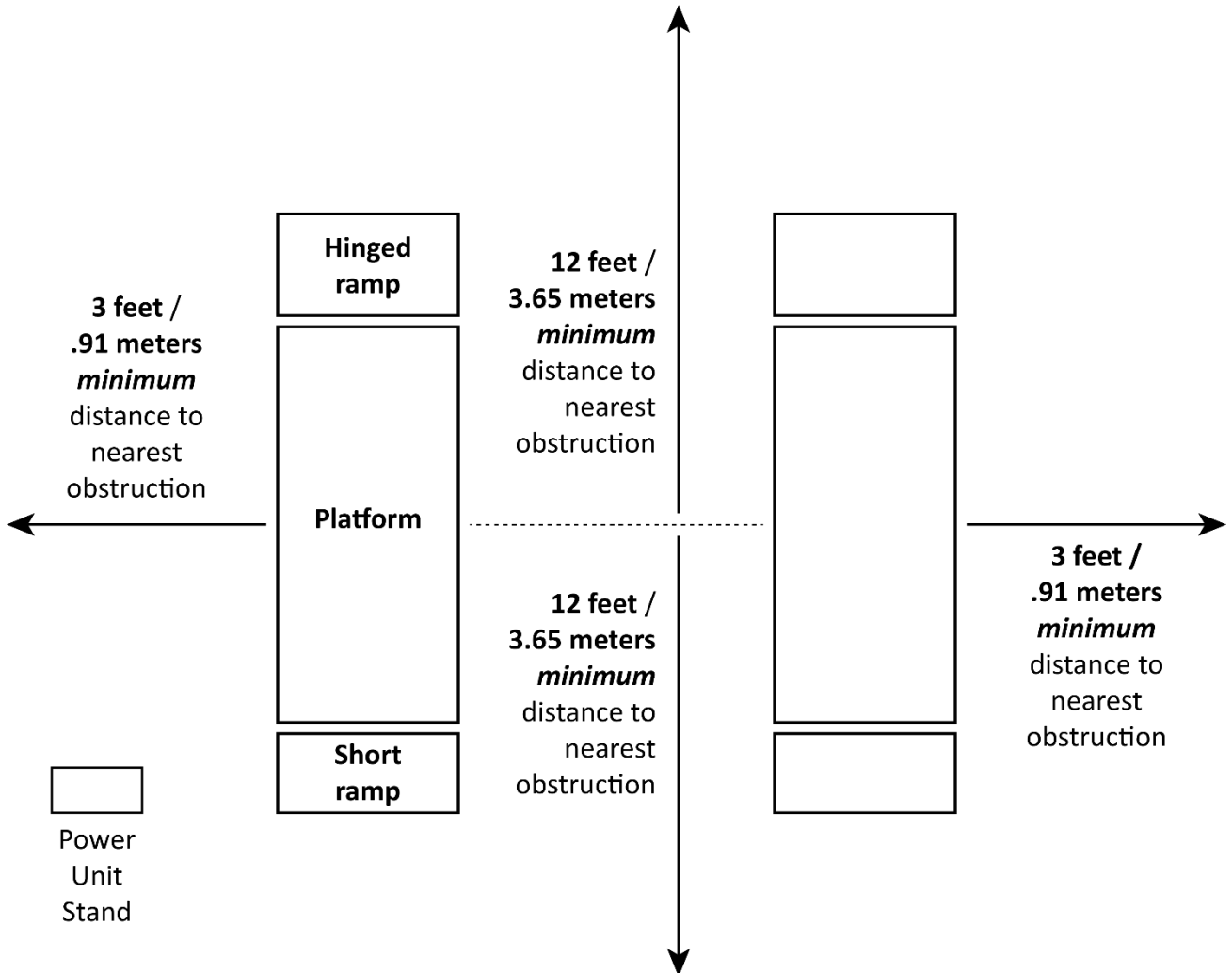

The Power Unit Stand can be on either side of the Lift, but it must be on the Short Ramp end.

You also need to make sure to leave enough space **above** the Vehicles you will be raising. Be sure to check for low-hanging obstructions such as hanging lights, beams, and so on. **Do not install the Lift under low-hanging obstructions.**

Create Chalk Line Guides

Make sure to plan out, in advance, where the LR-10000 is going to go:

- **Clearance.** Before anchoring your Lift, make sure there is appropriate clearance on all sides of the desired location and above.
- **Power Unit Stand.** The Power Unit Stand can be installed on the left or the right of the Lift (when looking at it from the Short Ramp end). When installed on the left, the Power Unit Stand can be up to 77 inches / 1,956 mm from the left side of the Lift. When installed on the right, the Power Unit Stand can be up to 53 inches / 1,346 mm from the right side of the Lift.
- **Operator.** The operator at the Power Unit Stand **must** have a full, unobstructed view of the LR-10000.
- **Power.** The Power Unit Stand must also be positioned near an appropriate power source, as that is where the Power Unit is going to be.
- **Set up Chalk Line Guides.** Create Chalk Line Guides to make sure the LR-10000 is positioned correctly.

To add Chalk Line Guides:

1. Decide where you want to locate the Lift.
2. Create an Alignment Chalk Line where you want one end of the LR-10000.

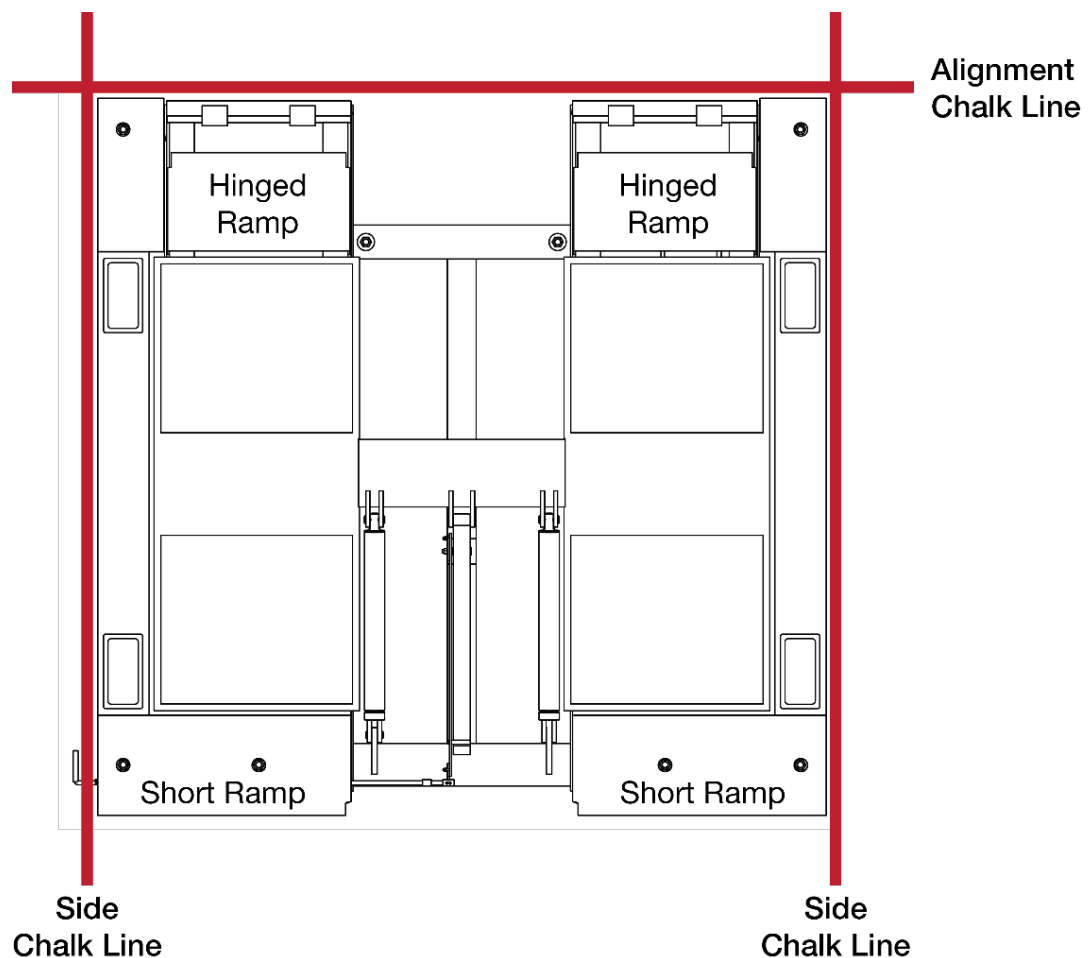

Not all components shown. Neither the Safety Lock Release Handle nor the Power Unit Stand are taken into consideration when creating Chalk Line Guides.

Make the Alignment Chalk Line longer than the **Overall width** of the LR-10000.

Refer to **Specifications** for exact measurements.

3. Create two Side Chalk Lines, one on each side of the Lift.

These Side Chalk Lines both need to be at 90 degree angles to the Alignment Chalk Line and parallel to each other.

Make the Side Chalk Lines longer than the **Overall length** of the Lift.

Refer to **Specifications** for exact measurements.

4. Move the Lift into position: one end just inside the Alignment Chalk Line and the two sides just inside the two Side Chalk Lines.
5. When the Platforms are in the correct location, they can be anchored into place.



Tip

Before anchoring the Lift, check to make sure there is an appropriate location for the Power Unit Stand: close to a power source and within reach of the Hydraulic Lines provided with the Lift.

Anchor the Bases

The LR-10000 has eight holes for anchoring it. Anchoring provides stability to hold the Vehicles you raise firmly in place.

Anchor Bolt specifications are:

- **Length:** 4.75 inches
- **Diameter:** 3/4 inch
- **Effective embedment depth:** 2.75 inches, minimum
- **Anchor torque:** 110 – 150 foot pounds

⚠ WARNING **Only use the factory-supplied parts that came with your lift.** If you use parts from a different source, you void your warranty and compromise the safety of everyone who installs or uses the Lift.

The following drawing shows the locations of the Anchor Bolt holes in the LR-10000.

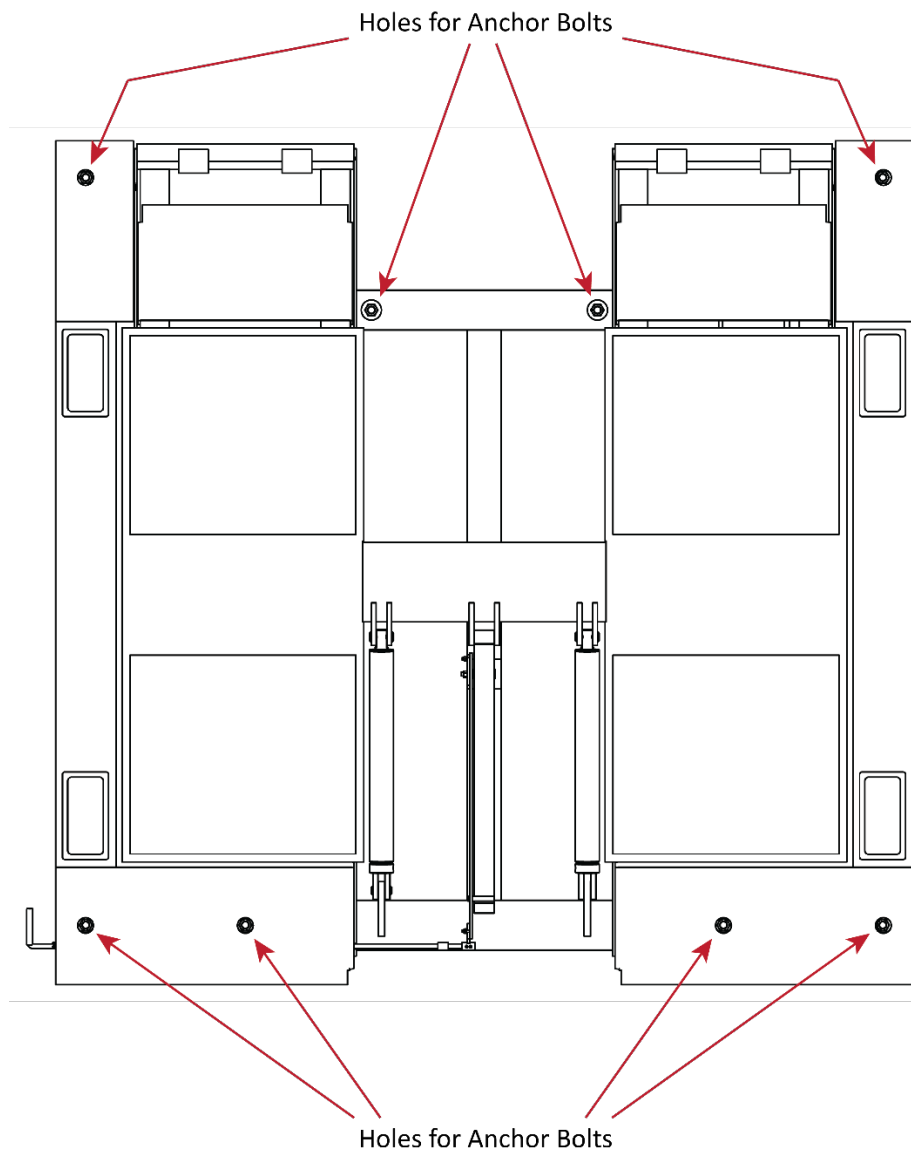

Not necessarily to scale. Not all components shown.

To anchor your LR-10000:

1. Make sure the Lift is in the correct location.

Once the Anchor Bolts are torqued into position, they are not easily removed. BendPak strongly recommends making sure the Lift is in the correct location **before** anchoring it into place.

2. Using the eight holes in the Base as guides, drill the holes for the Anchor Bolts.

Note: If you prefer, you can mark the Anchor Bolt hole locations, move the unit out of the way, drill the holes, and then move the unit back into position.

When drilling, go in straight; do not let the drill wobble.

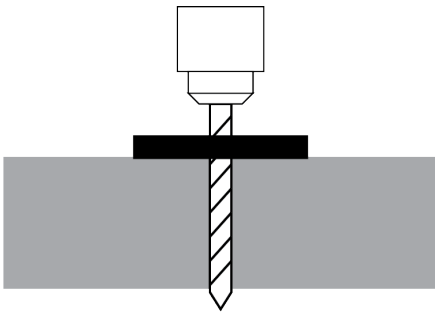

Use a carbide bit (conforming to ANSI B212.15-1994).

The diameter of the drill bit **must** be the same as the diameter of the Anchor Bolt. So if you are using a $\frac{3}{4}$ inch diameter Anchor Bolt, for example, use a $\frac{3}{4}$ inch diameter drill bit.

3. Use a vacuum to thoroughly clean each hole.

If a vacuum is not available, use a wire brush, hand pump, or compressed air.

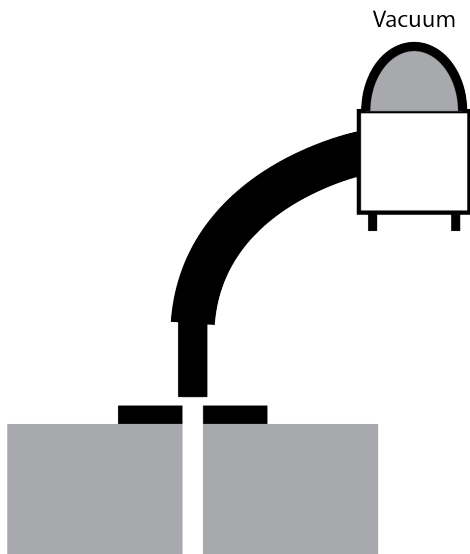

Do **not** ream the hole. Do **not** make the hole any wider than the drill bit made it.

-
4. Make sure the Washer and Nut are in place (you want approximately 1/4 inch to 1/3 inch — 6 to 8 mm — of thread visible above the nut), then insert the Anchor Bolt into the hole.

The Expansion Sleeve of the Anchor Bolt may prevent the Anchor Bolt from passing through the hole in the Base; this is normal. Use a hammer or mallet to get the Expansion Sleeve through the Base and down into the hole.

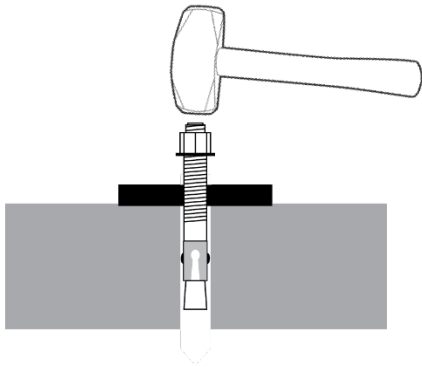

Even using a hammer or mallet, the Anchor Bolt should only go into the hole part of the way; this is normal. If the Anchor Bolt goes all the way in with little or no resistance, the hole is too wide.

Once past the hole in the Base, the Anchor Bolt eventually stops going down into the hole as the Expansion Sleeve contacts the sides of the hole; this is normal.

5. Hammer or mallet the Anchor Bolt the rest of the way down into the hole.
Stop hammering when the Washer is snug against the Base.
6. Wrench each Nut **clockwise** to the recommended installation torque, 110 – 150 foot pounds, using a Torque Wrench.

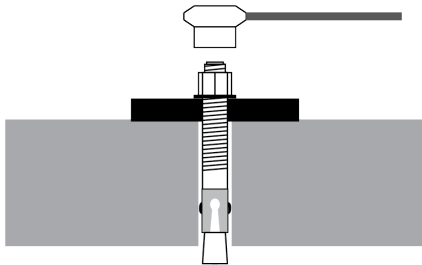

Important: Do **not** use an impact wrench to torque the Anchor Bolts.

Wrenching the Nut forces the wedge up, pushing out the Expansion Sleeve and pressing it tightly against the Concrete.

Install the Safety Lock Release Handle

This section describes how to install the Safety Lock Release Handle, which moves the Safety Lock Bar up so the Safety Locks cannot engage, allowing the Lift to be lowered back down to the ground.

Important: The Safety Lock Release Handle can only be installed in one location on the Lift. That location is under the Short Ramp on the left side of the Lift when you are looking at the Short Ramp side of the Lift.

The following drawing shows the components involved in installing the Safety Lock Release Handle.

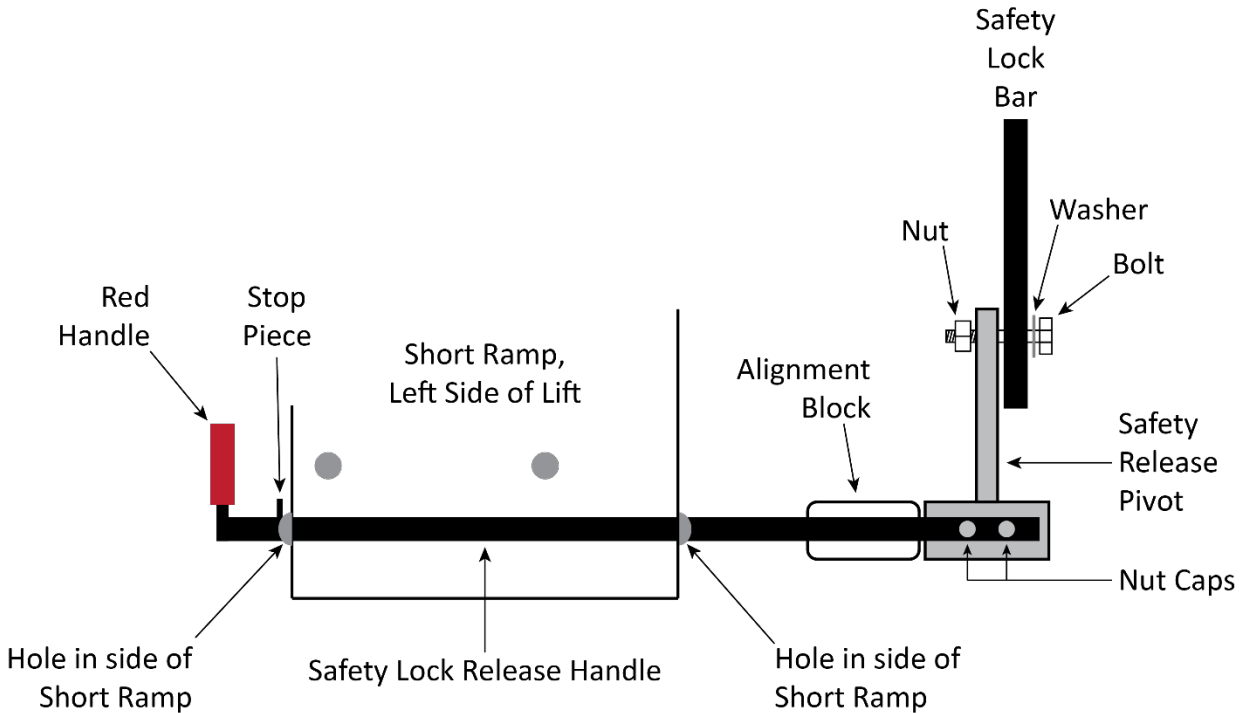

To install the Safety Lock Release Handle:

1. Find the Safety Lock Release Handle, the Safety Release Pivot, two Nut Caps, and one Bolt, Nut, and Washer.
2. Push the Safety Lock Release Handle through the hole on the left side of the Short Ramp until it comes out the hole on the right side of the Short Ramp.
3. Push on the Red Handle to guide the Safety Lock Release Handle through the Alignment Block.
4. Keep pushing until the Stop Piece is up against the left side of the Short Ramp.
5. Moving to the other end of the Safety Lock Release Handle, slip the Safety Release Pivot over the end of the Safety Lock Release Handle coming out of the Alignment Block.
6. Put on the Bolt, Washer, and Nut to secure the Safety Release Pivot.
7. Finger tighten the Nut.
8. Put the Nut Caps into place via the holes in the Safety Release Pivot.
9. Finger tighten the Nut Caps.
10. Move the Red Handle of the Safety Lock Release Handle up and back to make sure it is working.
11. Use appropriate tools to fully tighten the Nut and the Nut Caps.

Set Up the Power Unit Stand

The LR-10000 comes with a Power Unit Stand to hold the supplied Power Unit.

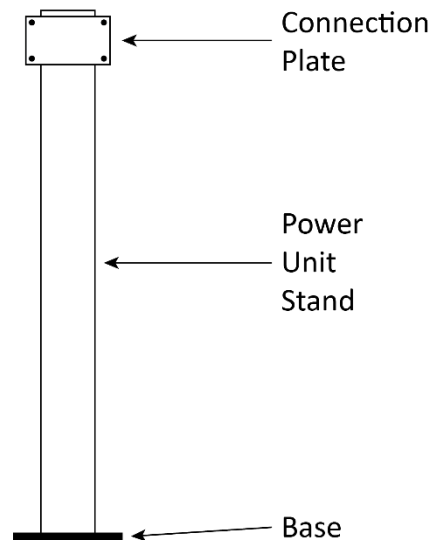

The Power Unit Stand can be on the left or right side of the Lift (looking at the Short Ramp end). Refer to the drawing in **Components** and **Clearance Around the Lift** for more information.

When installed on the left, the Power Unit Stand can be up to 77 inches / 1,956 mm from the left side of the Lift using the supplied Hydraulic Lines. When installed on the right, the Power Unit Stand can be up to 53 inches / 1,346 mm from the right side of the Lift.

The Power Unit Stand **must** be anchored. It cannot support the weight of the Power Unit unless it is anchored.

To set up the Power Unit Stand:

1. Select an appropriate site for the Power Unit Stand.

When selecting a site, remember that the Operator needs to have a full unobstructed view of the Lift, the Stand needs to be within a specific distance from the side of the Lift, and there needs to be an appropriate power source nearby.

2. Find the Power Unit Stand and the two Anchor Bolts ($\frac{3}{4}$ " wide, 4 $\frac{3}{4}$ " deep, same size as the Anchor Bolts holding down the Lift).
3. Using the holes in the Base of the Power Unit Stand as a guide, drill two holes $\frac{3}{4}$ " wide by 4" deep into the concrete.

Go in straight; do not let the drill wobble. Use a carbide bit (conforming to ANSI B212.15-1994).

4. Remove all dust from the holes.

Use a wire brush, vacuum, hand pump, or compressed air. Do **not** ream the hole. Do **not** make the hole any wider than the drill bit made it.

5. Insert an Anchor Bolt with Washer into each hole, then tap it down into the hole.
6. Turn the Anchor Bolt **clockwise** to the recommended installation torque, 90 – 110 foot pounds, using a Torque Wrench.

Attach the Power Unit

This section describes how to attach the Power Unit that comes with the Lift to the Connection Plate at the top of the Power Unit Stand.

Note: Attaching the Power Unit to the Power Unit Stand *does not involve any wiring* and so you do not need an Electrician. Later, when you connect the Power Unit to a power source, then an Electrician is required.

BendPak recommends having two people for the following procedure.

The Power Unit Stand **must** be anchored in place before performing the following procedure.

To attach the Power Unit to the Power Unit Stand:

1. Find the Power Unit and the supplied four Nuts, Bolts, and Washers.
2. Have one person hold the Mount Plate on the back of the Power Unit next to the Connection Plate at the top of the Power Unit Stand.

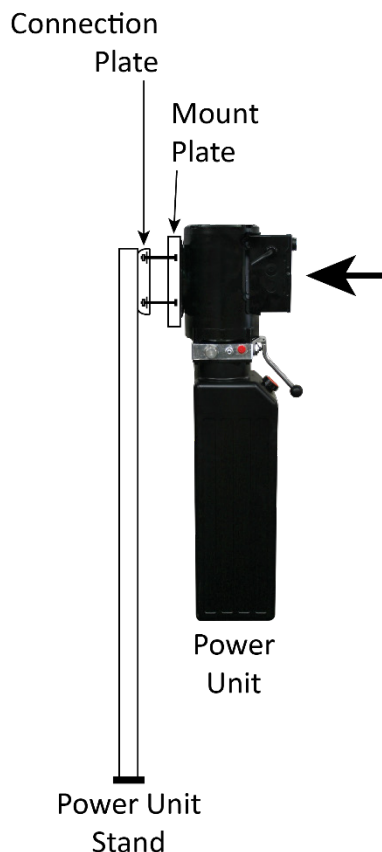

3. Have the second person finger tighten the four Nuts, Bolts, and Washers into place.
4. Use an appropriate tool to securely tighten the Nuts, Bolts, and Washers.

Connect the Hydraulic Lines

Hydraulic Lines provide Hydraulic Fluid to the Hydraulic Cylinders, where it is used to raise the Platforms.

The LR-10000 comes with one Long Hydraulic Line (black rubber) and one Short Hydraulic Line (silver metal). The Long Hydraulic Line goes from the Power Unit to the closest Hydraulic Cylinder. The Short Hydraulic Line goes from the first Hydraulic Cylinder to the other Hydraulic Cylinder.

The Short Hydraulic Line, and the two Hydraulic Fittings that go on either end of it, come installed from the factory.

Note: The drawings and instructions in this section assume the Power Unit Stand was installed on the left side of the Lift (looking at it from the Short Ramp end). If you installed it on the right side of the Lift, modify the instructions accordingly.

The following drawing is an overview of how the Hydraulic Lines are routed to the Hydraulic Cylinders.

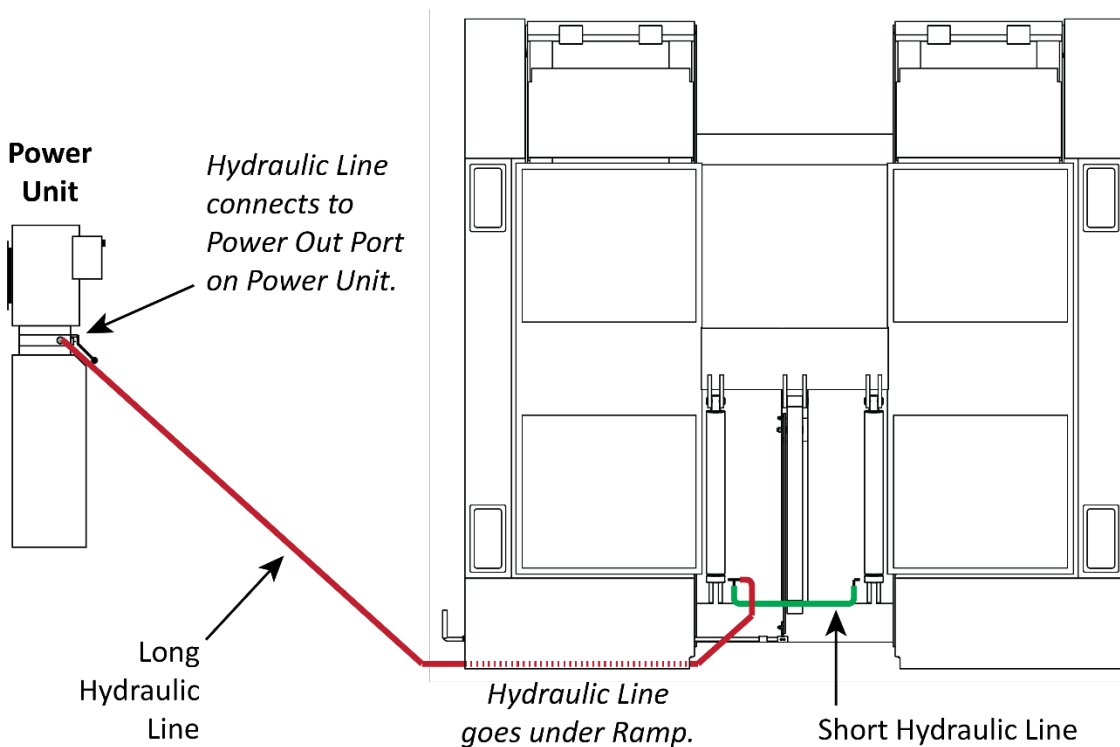

Drawing not necessarily to scale. Some components not shown, other components exaggerated for clarity. Power Unit shown on the left of the Lift (looking at the Short Ramp end).

To connect the Hydraulic Lines:

1. Locate the Long Hydraulic Line and the Elbow Hydraulic Fitting.
2. Starting at the Power Unit, remove the Shipping Plug from one of the two Hydraulic Power Out connectors on the Power Unit. It does not matter which one you use. They are labeled P1 and P2. The Hydraulic Power Out connectors are shown in the drawing in [Preparing the Power Unit](#).
3. Attach the Elbow Hydraulic Fitting (06 ORB – 04 JIC) to the Hydraulic Power Out connector whose Shipping Plug you removed.

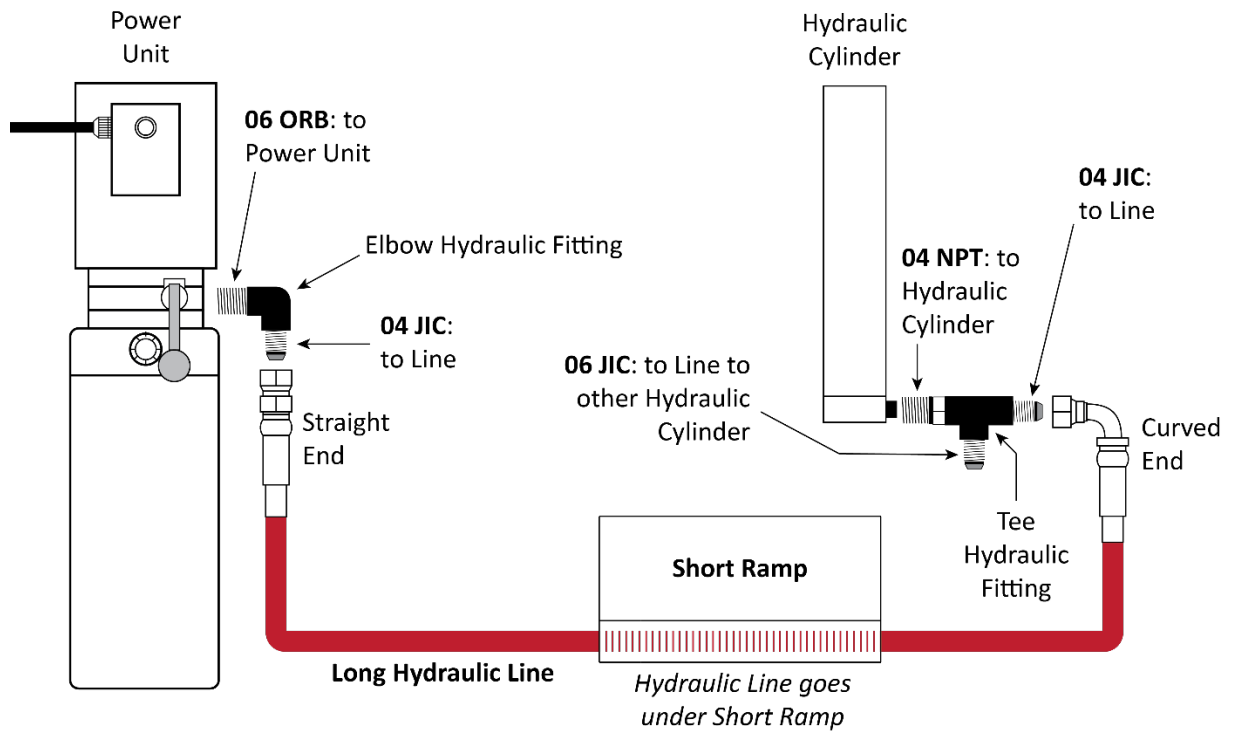

Drawing not to scale. Some components not shown, other components exaggerated for clarity. Fittings shown not connected for clarity.

4. Switching to the Long Hydraulic Line, attach the straight end of the Long Hydraulic Line to the Elbow Hydraulic Fitting on the Power Unit.
Finger tighten the connection.
5. Route the Long Hydraulic Line under the Short Ramp.
6. Attach the curved end of the Long Hydraulic Line to the open connector on the Tee Hydraulic Fitting on the Hydraulic Cylinder closest to the Power Unit.
The drawing above shows which connector to use.
Finger tighten the connection.
7. Switching to the Short Hydraulic Line, make sure it is in position and that both ends are connected to the Hydraulic Fittings that are connected to the Hydraulic Cylinders.

The drawing below shows the connections the Short Hydraulic Line makes.

Remember, the Short Hydraulic Line, and the two Hydraulic Fittings that go on either end of it, come installed from the factory.

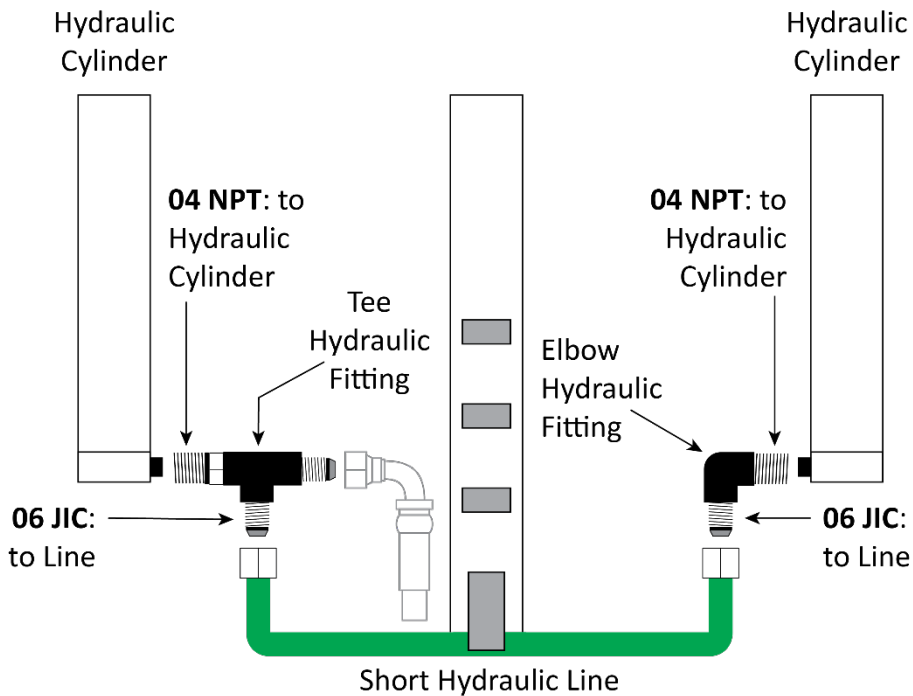

Drawing not to scale. Some components not shown, other components exaggerated for clarity. Fittings shown not connected for clarity.

9. Make sure both Hydraulic Lines are correctly routed, then use appropriate tools to **securely** tighten the finger-tightened connections.

Preparing the Power Unit

The Power Unit comes fully assembled from the factory. You need to attach it to the Power Unit Stand (already done, as described in [Attach the Power Unit](#)), connect it to a power source, and fill the Hydraulic Fluid Reservoir with Hydraulic Fluid.

The Power Unit for the LR-10000 is 208–240 VAC, 50/60 Hz, 1 phase. The Hydraulic Fluid Reservoir holds about 5.65 liters (1.5 gallons) of Hydraulic Fluid.

The Lift uses electrical energy; if your organization has Lockout/Tagout policies, make sure to implement them once the unit is connected to a power source.

⚠ DANGER All wiring **must** be performed by a licensed, certified Electrician.

Refer to [Wiring Diagram](#) for wiring information.

⚠ CAUTION The Power Unit's motor is **not** thermally protected.

The Power Unit has multiple connections:

- **Hydraulic Line.** The Hydraulic Line should already be connected to the Power Unit. If it is not, refer to [Connect the Hydraulic Lines](#) for more information.
- **Power Source.** The Power Unit has to connect to an appropriate power source. A licensed, certified Electrician is **required** to make this connection. The Electrician needs to provide an appropriate Power Cord and Plug; these are **not** supplied with the Lift.

The following drawing shows the Power Unit of the LR-10000.

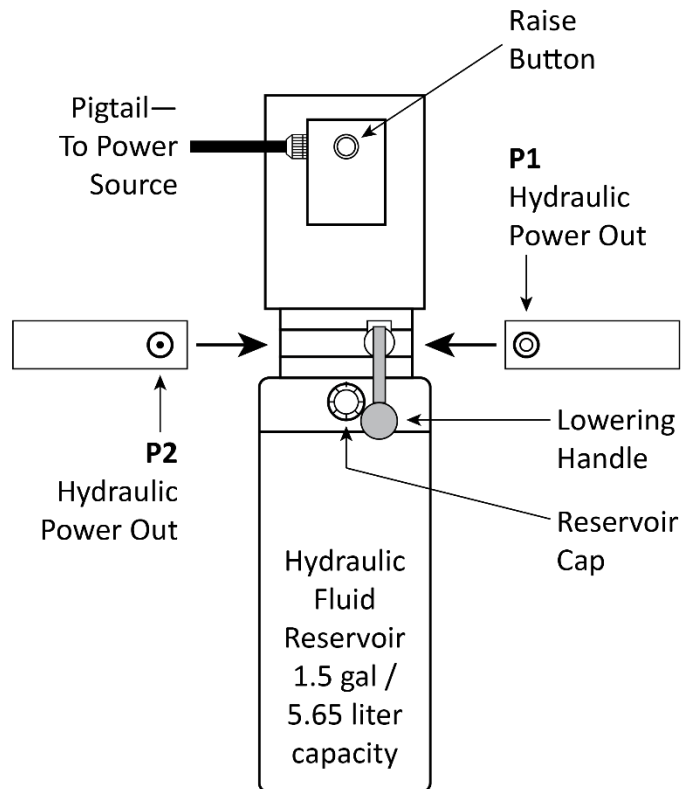

Drawing is not necessarily to scale. Your Power Unit may be different from what is shown here.

To connect to a Power Source and add Hydraulic Fluid:

1. Have the Electrician locate the Pigtail coming out of the Electrical Box on the Power Unit.
2. Open the Electrical Box, remove the Pigtail, and then wire a Power Cord (with an appropriate Plug) *inside the Electrical Box* to the wiring that was connected to the Pigtail.

The Electrician needs to provide the Power Cord and Plug; these are **not** supplied with the Lift.

Refer to **Wiring Diagram** for wiring information.

⚠ DANGER All wiring **must** be performed by a licensed, certified Electrician. Do not perform **any** maintenance or installation on the lift without first making sure that main electrical power has been disconnected from the lift and **cannot** be re-energized until all procedures are complete.

Important electrical information:

- Improper electrical installation can damage the Power Unit motor; this damage is not covered by the warranty.
 - If you have multiple Power Units, use a separate circuit breaker for each Power Unit.
 - Protect each circuit with a time-delay fuse or circuit breaker. For a 115 VAC, 1 phase circuit, use a 15 amp or greater fuse. For a 230 VAC, 1 phase circuit, use a 25 amp or greater fuse.
3. Fill the Hydraulic Fluid reservoir.

The Power Unit's Hydraulic Fluid reservoir must be filled with Hydraulic Fluid or automatic transmission fluid **before** you begin operation. When you receive it, the reservoir is empty; the Power Unit will not work correctly until it is filled with approved fluids.

Approved Hydraulic Fluids are any general purpose ISO-32, ISO-46, or ISO-68 hydraulic oil or approved automatic transmission fluids such as Dexron III, Dexron VI, Mercon V, Mercon LV, Shell Tellus S4 / S3 / S2, or any synthetic multi-Vehicle automatic transmission fluid.

⚠ WARNING Do not run your Power Unit without Hydraulic Fluid; you will damage it.

Install a Power Disconnect Switch

⚠ WARNING A Power Disconnect Switch is **not** provided with this equipment.

A Power Disconnect Switch is a National Electrical Code (NEC) requirement. They are designed to interrupt main electrical power in the event of an electrical circuit fault, emergency situation, or when equipment is undergoing service or maintenance.

Make sure to install a Power Disconnect Switch that is properly rated for the incoming power source.

Your Power Disconnect Switch must be installed so that it is in **easy reach of the Operator** or in their line of sight. The Power Disconnect Switch must be **clearly marked** to indicate its purpose.

If you are not clear where to put the Power Disconnect Switch, consult with your Electrician.

⚠ DANGER Installing a Thermal Disconnect Switch **must** be performed by a licensed, certified Electrician.

Have your Electrician select a **UL-listed** Power Disconnect Switch.

Install a Thermal Disconnect Switch

 **WARNING** The motor on the LR-10000 Power Unit has no thermal overload protection.

Have an Electrician connect a motor Thermal Disconnect Switch or overload device that will make sure the equipment shuts down in the event of an overload or an overheated motor.

 **DANGER** Installing a Thermal Disconnect Switch **must** be performed by a licensed, certified Electrician. Do not perform **any** maintenance or installation on the Lift without first making sure that main electrical power has been disconnected from the lift and **cannot** be re-energized until all procedures are complete.

High running amps that exceed the motor's full load amps (FLA) rating may result in permanent damage to the motor. **Do not exceed the rated duty cycle of the motor.**

Test the Lift

Before putting your Lift into normal operation, we recommend raising and lowering it a few times with a typical Vehicle on it.

This will help you get a feel for how to operate it and help get any residual air out of the Hydraulic System (sometimes called "bleeding" the system).



Tip

Residual air in the Hydraulic System can cause the Lift to shake, move erratically, or squeak; this is normal when you first start using the Lift. It will soon stop doing this, as the Hydraulic System is self-bleeding.

To test your Lift:

1. Check the items listed in **Lift Operation Safety**.

If you find any issues, resolve them before raising the Vehicle.

2. Make sure both Platforms are fully lowered.
3. Drive the Vehicle over the Platforms and situate it correctly.

 **CAUTION** Make sure to situate the Vehicle so that neither the front nor the rear wheels are over the Platforms. If you raise the Platforms with the wheels over the Platforms, you could damage the wheels.

4. Put the Vehicle in park, put on the parking brake, and turn off the Vehicle.

If the Vehicle is a manual transmission, put it into first gear before turning it off.

You do not want the Vehicle moving while it is raised.

5. Walk around the Vehicle and make sure there are no obstructions or any other issues that will interfere with the raising of the Platforms.
6. Locate the manufacturer's recommended Lifting Points for the Vehicle you are raising.

If you are unsure where the Lifting Points are, consult *Vehicle Lifting Points for Frame Engaging Lifts*, which was provided with the Lift, or the manufacturer of the Vehicle. If you no longer have *Vehicle Lifting Points for Frame Engaging Lifts*, you can get a replacement on the ALI website.

 **WARNING** Do not 'eyeball' the best location for the Lift Pads. **The Lift Pads must hit the manufacturer's recommended Lifting Points.** If you do not, the Vehicle could become unstable and fall, which could damage the Vehicle, damage the Lift, or injure or even kill anyone under the Vehicle.

7. Put the Lift Pads under the Vehicle so that they are **directly under** the Lifting Points for the Vehicle you are raising.

If necessary, use the included Lift Pad Extensions for extra height. You can also stack them.

8. On the Power Unit, press and hold the **Raise** button to raise the Lift until **just before** the Lift Pads make contact with the Lifting Points on the underside of the Vehicle.
9. Check to make sure the Lift Pads will make solid contact with the Lifting Points when raised further.

Adjust them if necessary.

10. Raise the Lift until the tires of the Vehicle are a few inches off the ground.

11. Visually check to make sure the Lift Pads are making solid contact with the Lifting Points.

If any of the Lift Pads are **not** making solid contact with the Lifting Points, lower the Lift and adjust the Lift Pads so that they make better contact.

12. Rock the Vehicle to make sure the Vehicle is stable and balanced.

If the Vehicle is **not** stable and balanced, lower the Lift back to the ground and start over.

If the Vehicle **is** stable and balanced, it is safe to raise further.

 **DANGER** Do not raise the Lift further until you are certain the Vehicle on the Lift is both stable and balanced. If the Vehicle is **not** stable and balanced, it could fall, which could damage the Vehicle, damage the Lift, or injure or kill anyone under the Vehicle.

13. On the Power Unit, press and hold the **Raise** button.

14. Watch the Vehicle and the Platforms as they rise.

If the Lift becomes unstable or the Vehicle starts moving, release the **Raise** button immediately.

15. When the Platforms are **just past** the desired height, release the **Raise** button.

The Lift stops rising.

16. Press the Lowering Handle on the Power Unit to move the Platforms back down a little, which engages them on the most recently passed Safety Lock.

If you miss the Safety Lock, press and hold **Raise** again and go somewhat further past the Safety Lock, then hold the Lowering Handle again to engage the Lift on the Safety Lock.

17. To lower the Lift back down to the ground, pull up on the Safety Lock Release Handle, then press and hold the Lowering Handle until the Lift is fully lowered.

If the Lift was shaking, moving erratically, or squeaking, raise and lower the Lift again to help bleed the Hydraulic System.

If you continue to have issues, refer to **Troubleshooting** for assistance.

Final Checklist Before Operation

Make sure the following items have been done before using your Lift:

- Review the **Installation Checklist** to make sure all steps have been performed.
- Make sure the Power Unit is getting power from the power source.
- Check the Hydraulic Fluid reservoir; it must be full of approved Hydraulic Fluid or automatic transmission fluid. **You can harm the motor by running it without enough fluid.**
- Check the Hydraulic System for leaks.
- Check to see that all Anchor Bolts are appropriately shimmed and correctly torqued.
- Make sure that all Safety Locks are cleared and free.

Leave the Manual with the Owner/Operator

Make sure to leave the *Installation and Operation Manual* with the owner/operator so that it is available for anyone who needs to read it.

Operation

This section describes how to operate your Lift.

 **WARNING** Use care around the Lift. When it is in a lowered position, be careful not to trip over it. When it is raised, be careful not to bang into the Ramps or the Platforms. **When the lift is moving, keep everyone at least 30 feet away from it.**

Lift Operation Safety

BendPak recommends referring to the ANSI/ALI ALIS Standard (R2015) *Safety Requirements for Installation and Service* for more information about safely installing, using, and servicing your Lift.

Before you raise or lower a Vehicle using your Lift, do the following each time:

- **Check the Lift.** Check the Lift for any missing, heavily worn, or damaged parts. Do not operate the Lift if you find any issues; instead, take it out of service, then contact your dealer, email techsupport@bendpak.com, visit bendpak.com/support, or call **(800) 253-2363**, x196.
- **Check the area.** Check the area around the lift for obstructions; anything that might block the Lift. Do not forget to check **above** the Lift. If you find an obstruction, move it out of the way.
- **Check the operators.** Make sure everyone who is going to operate the Lift has been trained in its use, has read the labels on the unit, and has read the manual. Only the operator at the Console should be within 30 feet of the Lift when it is in motion.
- **Check for safety.** Make sure everyone who is going to be walking near the Lift is aware of its presence and takes appropriate safety measures. Only put Vehicles on the Lift. **When raising the Lift, do not leave it until it is engaged on a Safety Lock.** When lowering the Lift, do not leave it until it is fully lowered. Do not allow children or untrained personnel to operate the Lift. Do not allow anyone under the influence of drugs or alcohol to operate the Lift.
- **Check the Vehicle.** Never exceed the Lift's weight rating. Do not allow people inside a Vehicle you are going to raise. Before raising it, make sure the Vehicle is not overbalanced on either end. Make sure you know and use the manufacturer's recommended Lifting Points for the Vehicle. Never raise just one side, one corner, or one end of a Vehicle.

Controlling the Lift

The controls on the Lift are:

- **Raise** button. Moves the Platforms up. Round black button, located near the top of the Power Unit. Shown in the drawing of the Power Unit in **Preparing the Power Unit**.
- **Lowering Handle**. Moves the Platforms down. Handle with round ball at end, located near the middle of the Power Unit. Shown in the drawing of the Power Unit in **Preparing the Power Unit**.
- **Safety Lock Release Handle**. When lowered, allows the Safety Locks to engage. When raised, prevents the Safety Locks from engaging. Lowered and raised positions shown in the following diagram.

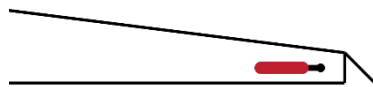

Lowered.
Safety Locks **can** engage

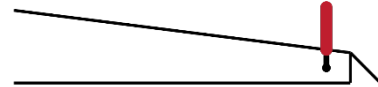

Raised.
Safety Locks **cannot** engage

Not necessarily to scale. Not all components shown. Side view.

About Safety Locks

Your Lift comes with three Safety Lock positions; they serve two important functions:

- **Safety**. Safety Locks hold the Platforms in place. Once the Platforms are engaged on Safety Locks, the weight of the Vehicle holds the Platforms in place. If the power goes out, the Safety Locks continue to hold the Platforms, and anything on them, in place.

⚠ WARNING Always leave your Lift engaged on a Safety Lock or on fully lowered. Although rare, it is possible for Hydraulic Fluid in the Hydraulic Cylinders to leak, causing the Platforms to slowly come down. **Always leave it your Lift either fully lowered or engaged on a Safety Lock.**

- **Adjustable height**. Having multiple Safety Lock positions means you can raise the Vehicle to just the right height for the work you are performing.

The following diagram is a side view of various Safety Lock conditions.

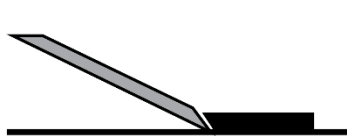

Engaged on Safety Lock

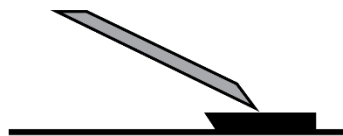

Passing over Safety Lock

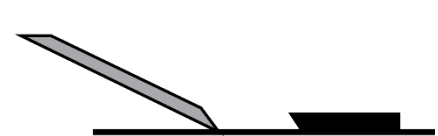

Not engaged on Safety Lock

Not necessarily to scale. Not all components shown. Some components shown exaggerated for clarity.

Raising a Vehicle

This section describes how to position a Vehicle on the Lift and raise it.

To raise a Vehicle:

1. Check the items listed in **Lift Operation Safety**.

If you find any issues, resolve them **before** raising the Vehicle.

Only use the Lift if it can be used safely.

2. Make sure both Platforms are fully lowered.
3. Drive the Vehicle over the Platforms and situate it correctly.

⚠ CAUTION Make sure to situate the Vehicle so that neither the front nor the rear wheels are over the Platforms. If you raise the Platforms with the wheels over the Platforms, you could damage the wheels.

4. Put the Vehicle in park, put on the parking brake, and turn off the Vehicle.

If the Vehicle is a manual transmission, put it into first gear before turning it off.

You do not want the Vehicle moving while it is raised.

5. Walk around the Vehicle and make sure there are no obstructions or any other issues that will interfere with the raising of the Platforms.

6. Locate the manufacturer's recommended Lifting Points for the Vehicle you are raising.

If you are unsure where the Lifting Points are, consult *Vehicle Lifting Points for Frame Engaging Lifts*, which was provided with the Lift, or the manufacturer of the Vehicle. If you no longer have *Vehicle Lifting Points for Frame Engaging Lifts*, you can get a replacement on the ALI website.

⚠ WARNING: Do not 'eyeball' the best location for the Lift Pads. **The Lift Pads must hit the manufacturer's recommended Lifting Points**, if they do not, the Vehicle could become unstable and fall, which could damage the Vehicle, damage the Lift, or injure or even kill anyone under or near the Vehicle.

7. Put the Lift Pads under the Vehicle so that they are **directly under** the Lifting Points for the Vehicle you are raising.

If necessary, use the included Lift Pad Extensions for extra height.

8. On the Power Unit, press and hold the **Raise** button to raise the Lift until **just before** the Lift Pads make contact with the Lifting Points.

9. Check to make sure the Lift Pads will make solid contact with the Lifting Points when raised further.

Adjust them if necessary.

10. Raise the Lift until the tires of the Vehicle are a few inches off the ground.

11. Visually check to make sure the Lift Pads are making solid contact with the Lifting Points.

If any of the Lift Pads are **not** making solid contact with the Lifting Points, lower the Lift and adjust the Lift Pads so that they make better contact.

12. Rock the Vehicle to make sure the Vehicle is stable and balanced.

If the Vehicle is **not** stable and balanced, lower the Lift back to the ground and start over.

If the Vehicle **is** stable and balanced, it is safe to raise further.

⚠ DANGER Do not raise the Lift further until you are certain the Vehicle on the Lift is both stable and balanced. If the Vehicle is **not** stable and balanced, it could fall, which could damage the Vehicle, damage the Lift, or injure or kill anyone under the Vehicle.

13. On the Power Unit, press and hold the **Raise** button.

14. Watch the Vehicle and the Platforms as they rise.

If the Lift becomes unstable or the Vehicle starts moving, release the **Raise** button immediately.

15. When the Platforms are just past the desired height, release the **Raise** button.

The Lift stops rising.

16. Press the Lowering Handle to move the Platforms back down, which engages them on the most recently passed Safety Lock.

If you miss the Safety Lock, press and hold **Raise** again and go somewhat further past the Safety Lock, then hold the Lowering Handle again to engage the Lift on the Safety Lock.

Lowering a Vehicle

This section describes how to lower a Vehicle from a raised position.

To lower a Vehicle:

1. Check the items listed in **Lift Operation Safety**.

If you find any issues, resolve them before lowering the Vehicle.

Only use the Lift if it can be used safely.

2. Press and hold the **Raise** button for a second or two.

This moves the Platforms off the Safety Lock.

3. Move the Safety Lock Release Handle to the Raised position.

This pushes the Safety Lock Bar up, allowing the Safety Locks to be passed by.

4. Press and hold the Lowering Handle.

5. Release the Lowering Handle when the Lift is fully lowered.

6. Move the Safety Lock Release Handle back to the Lowered position.

7. Carefully drive the Vehicle off.

Maintenance

⚠ DANGER Before performing any maintenance, make sure the Lift is completely disconnected from power and **cannot** be re-energized until all maintenance is complete. BendPak strongly recommends using your Power Disconnect Switch during maintenance. If your organization has Lockout/Tagout policies, make sure to implement them during all maintenance.

To maintain your Lift:

- **Daily:** Keep the Lift clean. Wipe up any oil spills, clean any dirt.
- **Daily:** Make a visual inspection of all moving parts and check for damage or excessive wear. If you find any damaged or worn parts, take the Lift out of service until they are replaced.
- **Daily:** Make sure the Safety Locks are in good operating condition. If you find that the Safety Locks are damaged or excessively worn, take the Lift out of service until they are replaced. **Do not use your Lift if the Safety Locks are damaged or excessively worn.**
- **Weekly:** Check all controls to make sure they are functioning normally.
- **Weekly:** Check all labels on the unit. Replace them if they are illegible or missing.
- **Monthly:** Lubricate the grease fittings. We recommend using white lithium grease or similar.
- **Monthly:** Check the Power Unit's Hydraulic Fluid levels. Refill if low.
- **Every two months:** Check all Anchor Bolts to make sure they are tight. If not, tighten them.

⚠ WARNING: Do not operate your Lift if you find issues; instead, take the Lift out of service, then contact your dealer, email techsupport@bendpak.com, visit bendpak.com/support, or call **(800) 253-2363**, extension 196.

Lubrication

The following drawing shows the lubrication points for the Lift. Note that some lubrication points are under other parts of the Lift.

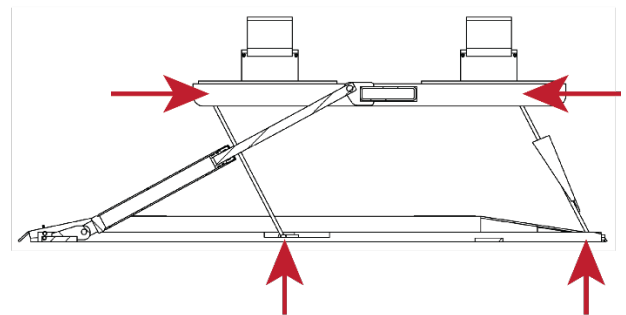
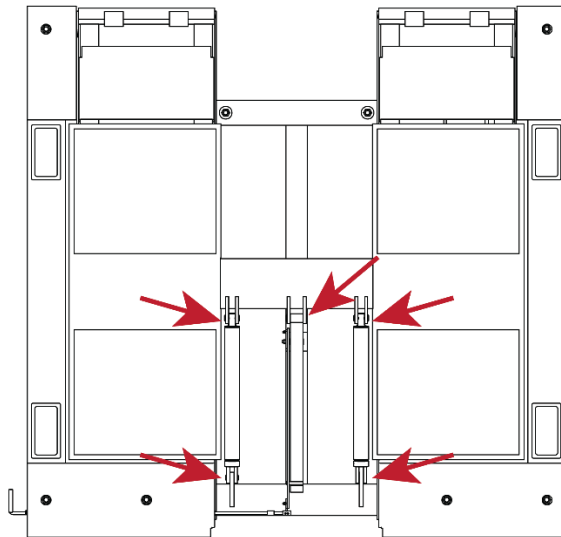

Troubleshooting

This section describes how to troubleshoot your Lift.

Note: If your Lift is not functioning correctly, you must take it out of service until it is fixed.

Important: All repair work **must** be done by qualified personnel.

Issue	Action to Take
Platforms move erratically or squeak when in use.	Move the Platforms up and down a few times, with a break between each; there could be residual air in the Hydraulic System.
Platforms do not go up or down.	Make sure the Power Unit is connected to an appropriate power source. Make sure the Hydraulic Lines are not pinched or leaking. Make sure there is sufficient Hydraulic Fluid in the reservoir on the Power Unit.
Vehicle with no tires is fully lowered, Lift will not go up.	Too much weight on the Frames; no room to get upward motion started. Refer to Vehicle with No Tires Fully Lowered .
Hydraulic Fluid is old or dirty.	Replace the dirty fluid with clean, approved Hydraulic Fluids, such as Dexron III, Dexron VI, Mercon V, Mercon LV, Shell Tellus S4 / S3 / S2, or comparable.
Platforms make odd noises when in use.	Lubricate hinge points using white lithium grease.
Platforms are slowly lowering on their own.	Make sure both Platforms are engaged on Safety Locks (if not, Hydraulic Fluid could be leaking out, lowering the Platforms). Only leave the Lift either fully lowered or engaged on a Safety Lock.

If you continue to have problems with your Lift, contact your dealer, visit bendpak.com/support, email techsupport@bendpak.com, or call **(800) 253-2363**, extension 196.

Vehicle with No Tires Fully Lowered

The issue is that there is too much weight on the LR-10000 Frames with no room to get upward force started. You need to reduce the weight by at least half or raise the Vehicle off the Frames some other way.

Methods that have fixed this issue include:

- Use a floor jack to raise the Vehicle from four to six inches, giving enough room to get upward force started
- Use lifting equipment to raise the Vehicle off the Frames

If you are still unable to raise your Vehicle, contact Technical Support for assistance.

Wiring Diagram

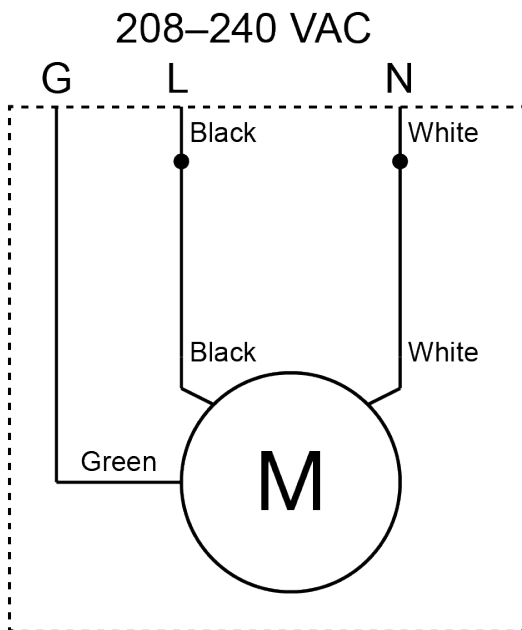

This wiring diagram shows the United States color codes for the three wires in the Pigtail that comes out of the electrical box on the Power Unit:

- **Black:** Live
- **White:** Live
- **Green:** Ground

If you are using the unit in a European country, these Black – White – Green colors correspond to:

- **Brown:** Live
- **Blue:** Neutral
- **Green/Yellow:** Ground

Information about color code conventions in other regions and countries is available online.



⚠ WARNING: All electrical work, such as hard-wiring the unit or attaching a Plug to the Power Cord, **must be done by a licensed, certified Electrician** in accordance with all applicable local electrical codes. Damage caused by improper electrical installation may void your warranty.

Labels

A



C

<p>Maximum Lifting Capacity 10,000 lbs. / 4536 kg</p> <p>WARNING!</p> <p>FAILURE TO READ AND UNDERSTAND THE FOLLOWING WARNINGS MAY RESULT IN PERSONAL INJURY AND/OR PROPERTY DAMAGE. KEEP HANDS AND FEET CLEAR FROM MOVING PARTS.</p> <p>Read and understand entire contents of operation manual and warnings below before operating this equipment.</p> <ul style="list-style-type: none"> ✓ Never exceed the rated capacity of the lift ✓ Do not operate the lift if any component is found to be defective or worn ✓ Never operate lift with any person or equipment below ✓ Always ensure load is centered and stable prior to operating controls ✓ When lowering the lift pay careful attention that all personnel and objects are kept clear ✓ Always keep a visual line of site on the lift during operation ✓ Always stand clear of lift when lowering or raising ✓ Never leave lift in elevated position unless safety lock is engaged in the LOCKED position ✓ Keep all body parts and objects away from pinch points when lift is in motion ✓ Use on level concrete in good condition and free of cracks or other defects ✓ Visually confirm safety lock is properly engaged before working on or near lift 	<p>Maximum Lifting Capacity 10,000 lbs. / 4536 kg</p> <p>WARNING!</p> <p>ALWAYS ensure that the safety is in LOCKED position before any attempt is made to work on or near the vehicle.</p> <p>LOCKED POSITION</p>  <p>UNLOCKED POSITION</p> 	<p>LR SERIES LIFT OPERATION INSTRUCTIONS</p> <p>TO RAISE LIFT</p> <ol style="list-style-type: none"> 1. Clear area of personnel and make sure lift is in full lowered position. 2. Drive vehicle over lift platforms making sure centerline of the vehicle is positioned properly over lift pads. 3. Position vehicle with lift pads making secure contact with factory recommended lifting points. 4. Make sure vehicle weight does not exceed rated capacity of lift. 5. Depress the RAISE button to commence lifting. 6. Raise lift until the vehicles tires clear the floor then stop. 7. Check if vehicle is secure. 8. Continue raising vehicle to desired height. 9. Raise until the safety lock bars drop into the LOCKED position. 10. Lower lift until platforms park and settle on the LOCKED position. <p>TO LOWER LIFT</p> <ol style="list-style-type: none"> 1. Clear area before lowering lift. 2. Raise the lift until the release cam on the safety lock drops into the UNLOCKED position. 3. Push the LOWERING handle until the lift starts to descend. Stay clear of lift area. 4. Fully lower the lift and remove all lifting adapters before driving vehicle away. <p style="text-align: right;">ANSI CE</p> <p style="font-size: small;">Santa Paula, CA 93060 • TEL: 805-933-9970 • www.bendpak.com ENGINEERED BY BENDPAK USA • MADE IN CHINA</p>
--	--	---

D

BP BendPak PROVIDING AUTOMOTIVE SERVICE SOLUTIONS	SANTA PAULA, CA USA WWW.BENDPAK.COM PN 5909940
LIFT TYPE: SURFACE MOUNT CAP: MED/HVY DTY MFG. BPK SEE DATA PLATE FOR PRODUCT DETAILS	
POWER: ELECTRIC/HYDRAULIC INSTALLATION - SEE OWNERS GUIDE OR CONTACT FACTORY	
SAFETY INSTRUCTIONS: IF ATTACHMENTS, ACCESSORIES OR CONFIGURATION MODIFYING COMPONENTS THAT ARE LOCATED IN THE LOAD PATH, AFFECT OPERATION OF THE LIFT, AFFECT THE LIFT ELECTRICAL LISTING OR AFFECT INTENDED VEHICLE ACCOMMODATION ARE USED ON THIS LIFT AND, IF THEY ARE NOT CERTIFIED FOR USE ON THIS LIFT, THEN THE CERTIFICATION OF THIS LIFT SHALL BECOME NULL AND VOID CONTACT THE PARTICIPANT FOR INFORMATION PERTAINING TO CERTIFIED ATTACHMENTS, ACCESSORIES OR CONFIGURATION MODIFYING COMPONENTS.	
BENDPAK LIFTS ARE SUPPLIED WITH CONCRETE FASTENERS MEETING THE CRITERIA AS PRESCRIBED BY ASTM E488 - 96(2003). LIFT BUYERS ARE RESPONSIBLE FOR ANY SPECIAL REGIONAL STRUCTURAL AND/OR SEISMIC ANCHORING REQUIREMENTS SPECIFIED BY ANY OTHER AGENCIES AND/OR CODES SUCH AS THE UNIFORM BUILDING CODE (UBC) AND/OR INTERNATIONAL BUILDING CODE (IBC).	
THE MANUFACTURE, USE, SALE OR IMPORT OF THIS PRODUCT MAY BE SUBJECT TO ONE OR MORE UNITED STATES PATENTS, OR PENDING APPLICATIONS, OWNED BY BENDPAK, INC. DO NOT REMOVE ENGINEERED BY BENDPAK INC. USA MADE IN CHINA	

E

BP BendPak Santa Paula, CA USA www.bendpak.com	
MODEL NUMBER	
DESCRIPTION	
LIFT CAPACITY DATE OF MFG.	
VOLTAGE <input type="checkbox"/> 110-240V, 50-60 Hz, 1 Ph <input type="checkbox"/> 208-240V, 50-60 Hz, 1 Ph <input type="checkbox"/> 380-415V, 50-60 Hz, 3 Ph <input type="checkbox"/> 228-440V, 50-60 Hz, 3 Ph	SERIAL NUMBER UPC
DANGER! Disconnect Power Before Servicing WARRANTY VOID IF DATA PLATE IS REMOVED PN 5909951	
ERC	

F

CERTIFIED AUTOMOTIVE LIFT



Automotive Lift Institute, Inc. | Cortland, NY 13045

ALI CERTIFIED
To the provisions of
ANSI/ALCTV-2011
SAFETY REQUIREMENTS FOR
CONSTRUCTION, TESTING
AND VALIDATION

MET LISTED
Conforms to
ANSI/UL 201
SAFETY STANDARD FOR
GARAGE EQUIPMENT



MET Laboratories, Inc.
BALTIMORE, MD 21230

Certification Label Serial Number



AL00617000J

B



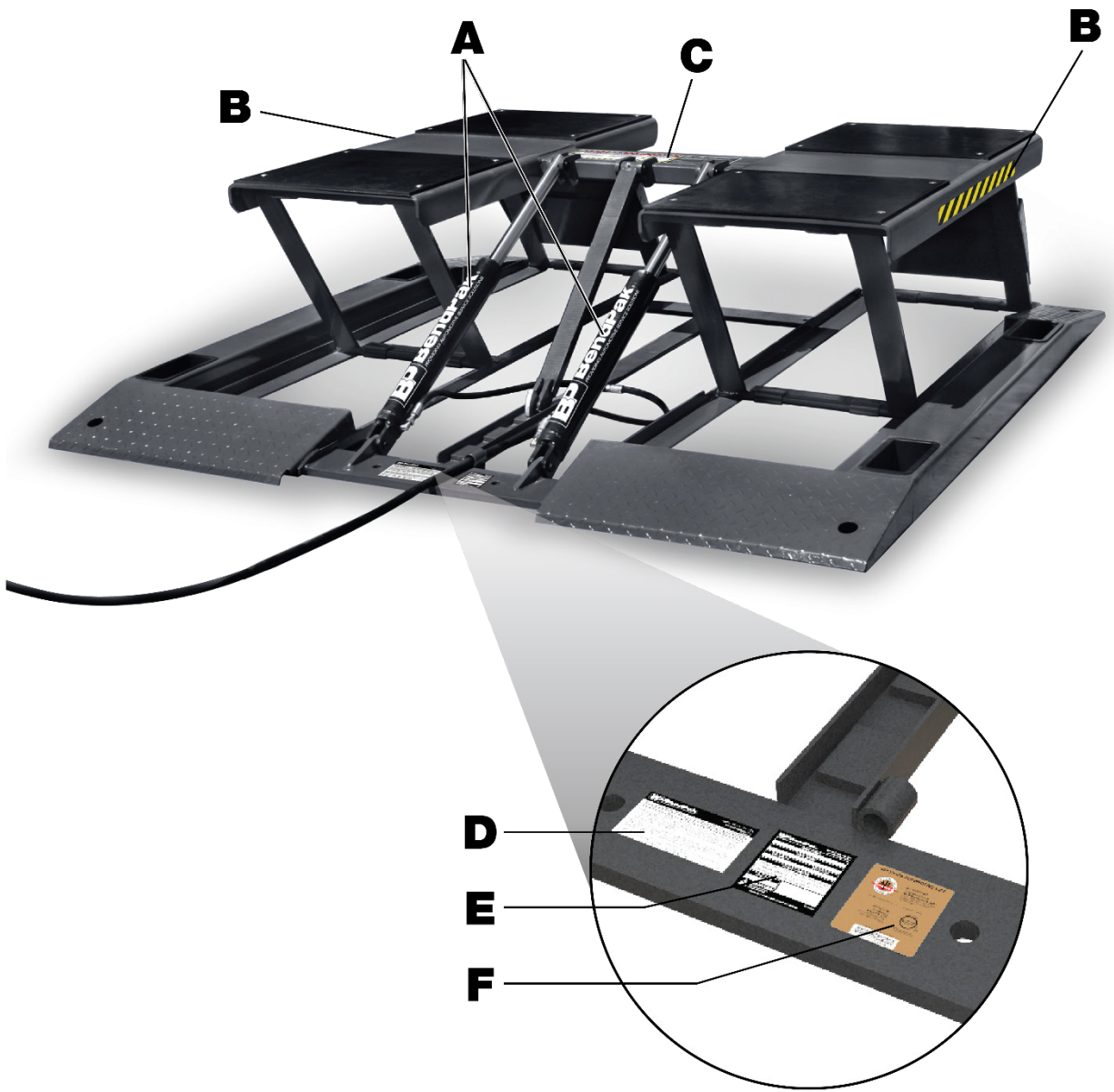

Parts Diagrams

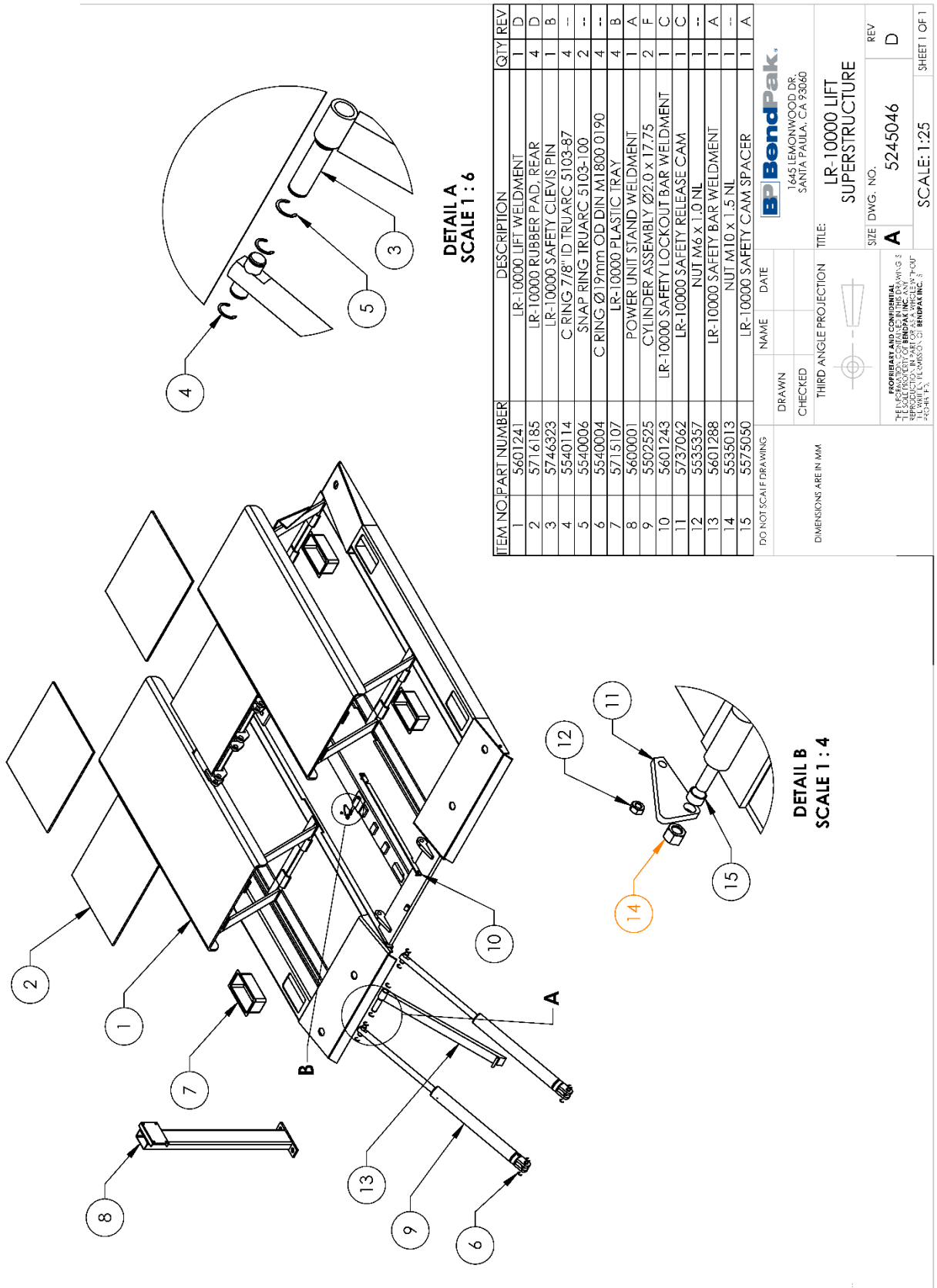

DETAIL A
SCALE 1 : 6

DETAIL B
SCALE 1 : 4

ITEM NO.	PART NUMBER	DESCRIPTION	QTY	REV
1	5601241	LR-10000 LIFT WELDMENT	1	D
2	5716185	LR-10000 RUBBER PAD, REAR	4	D
3	5746323	LR-10000 SAFETY CLEVIS PIN	1	B
4	5540114	C RING, 7/8" ID, TRUARC 5103-87	4	--
5	5540006	SNAP RING, TRUARC 5103-100	2	--
6	5540004	C RING Ø19mm OD DIN M1800 0190	4	--
7	5715107	LR-10000 PLASTIC TRAY	4	B
8	5600001	POWER UNIT STAND WELDMENT	1	A
9	5502525	CYLINDER ASSEMBLY Ø2.0 x 17.75	2	F
10	5601243	LR-10000 SAFETY LOCKOUT BAR WELDMENT	1	C
11	5737062	LR-10000 SAFETY RELEASE CAM	1	C
12	5535357	NUT M6 x 1.0 NL	1	--
13	5601288	LR-10000 SAFETY BAR WELDMENT	1	A
14	5535013	NUT M10 x 1.5 NL	1	--
15	5575050	LR-10000 SAFETY CAM SPACER	1	A

BendPak.

1645 LEMONWOOD DR.
SANTA PAULA, CA 93060

TITLE: LR-10000 LIFT
SUPERSTRUCTURE

SIZE DWG. NO. A 524-5046 REV D

SCALE: 1:25 SHEET 1 OF 1

DO NOT SCALE DRAWING

DRAWN NAME DATE

CHECKED

THIRD ANGLE PROJECTION

DIMENSIONS ARE IN MM

FOR PARTS AND COMPONENTS
PLEASE CONTACT THE BENDPAK INC. PARTS
DEPARTMENT AT 1645 LEMONWOOD DR.
SANTA PAULA, CA 93060
TEL: (415) 253-5000 FAX: (415) 253-5001
WWW.BENDPAK.COM

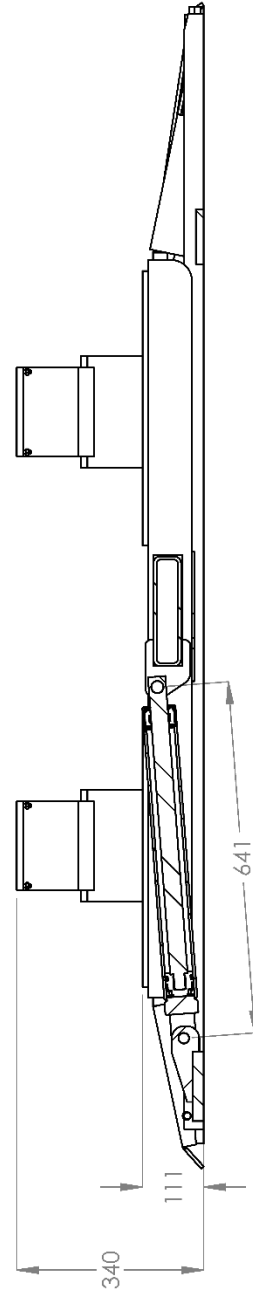
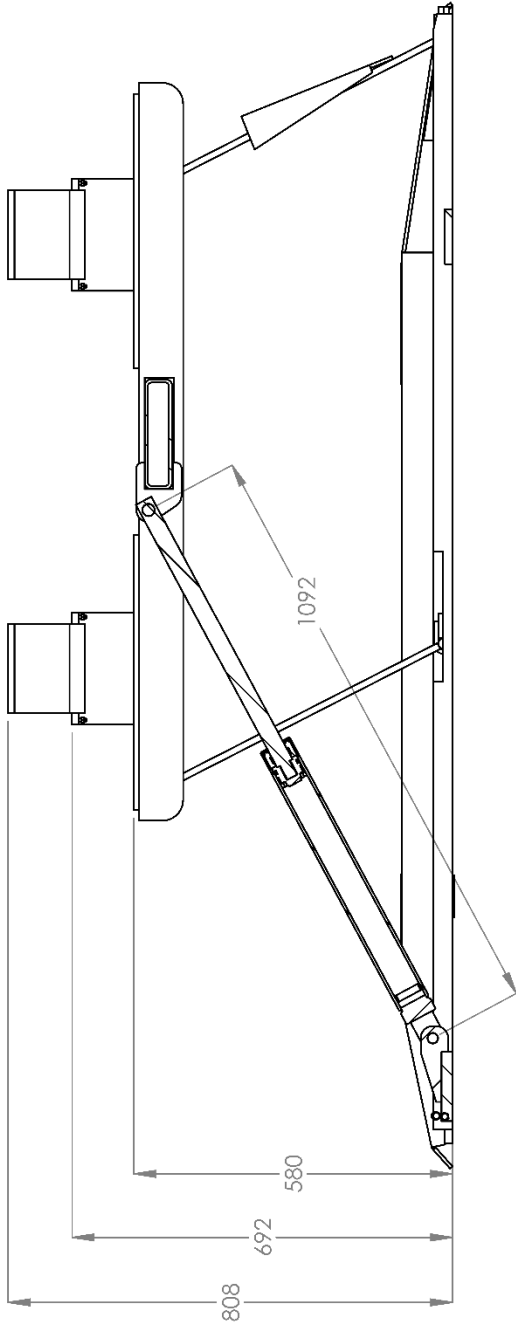

 1645 LENOXWOOD DR. SANTA PAULA, CA 93060	
TITLE:	LR-10000 PRODUCTION LIFT
SIZE DWG. NO.	A 5260184
REV	E
SCALE:	1:12
	SHEET 2 OF 3

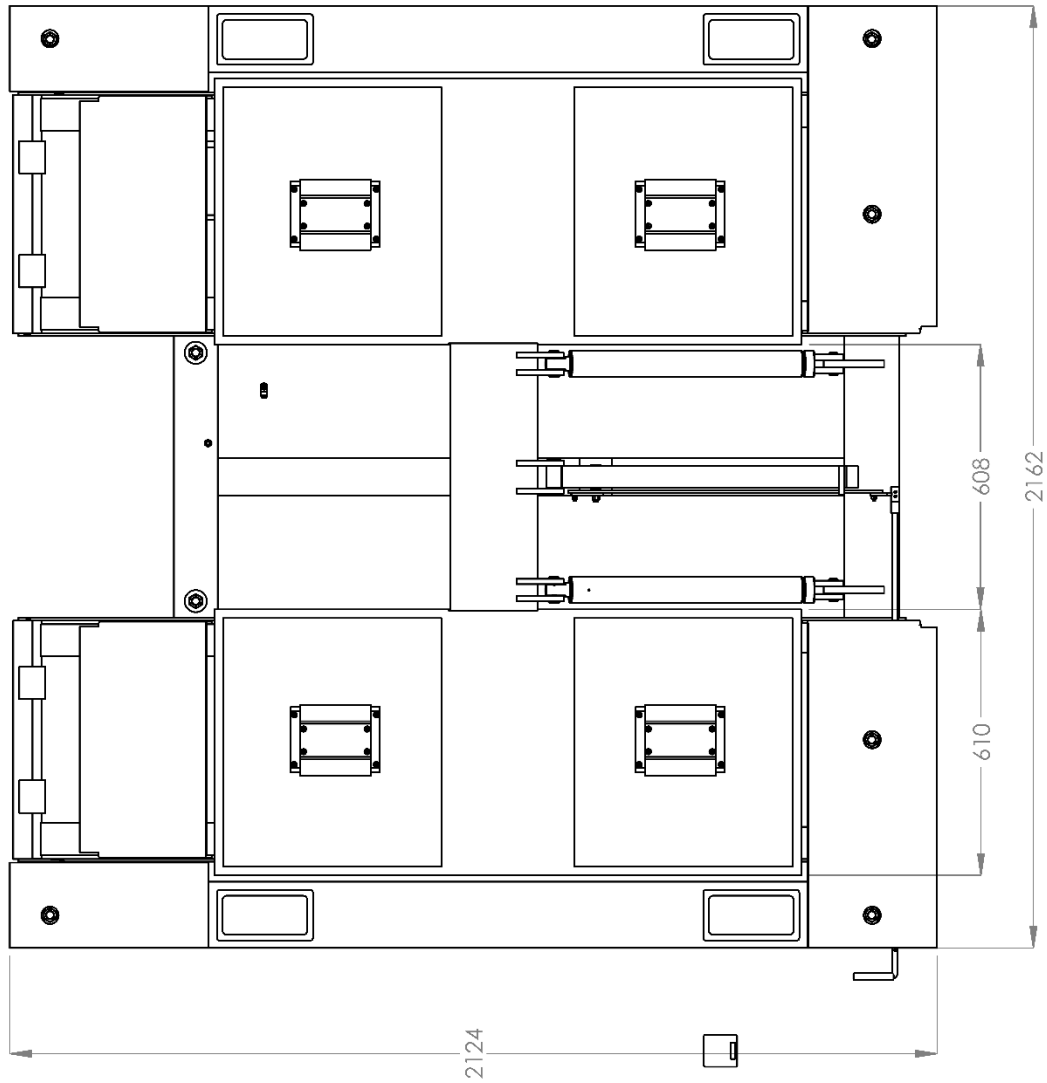

BP BendPak.
 1645 LEMONWOOD DR.
 SANTA PAULA, CA 93060

TITLE: LR-10000 PRODUCTION LIFT	
SIZE DWG. NO. A	REV E
SCALE: 1:15	
SHEET 3 OF 3	

Automotive Lift Institute (ALI) Store

You probably checked the [ALI's Directory of Certified Lifts](http://www.autolift.org/ali-directory-of-certified-lifts/) (www.autolift.org/ali-directory-of-certified-lifts/) before making your most recent Lift purchase, but did you know the **ALI Store** (www.autolift.org/ali-store/) offers a wide variety of professional, easy-to-use, and reasonably priced training and safety materials that will make your garage a safer place to work?

The ALI Store is your trusted source for workplace safety!

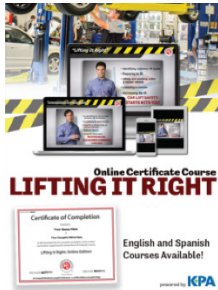

Lifting It Right Online Certificate Course. Make sure you and your people are lifting vehicles the right way.

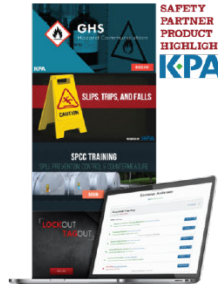

KPA Online Training Subscription. Get all of your people up to speed on automotive industry topics.

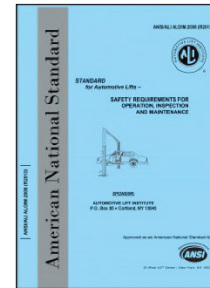

ANSI/ALI ALOIM Standard for Automotive Lifts. Safety Requirements for Operation, Inspection, and Maintenance.

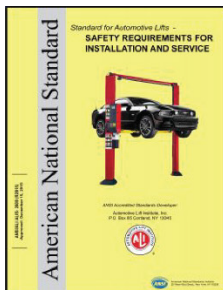

ANSI/ALI ALIS Standard. Safety Requirements for Installation and Service.

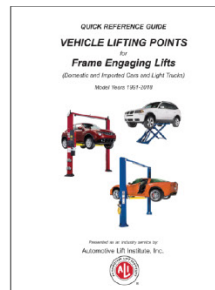

Guide to Hitting Vehicle Lifting Points for Frame-Engaging Lifts. Don't eyeball your lifting points, **know** where they are.



Lift Operator Safety Materials. Five safety documents in a single package.

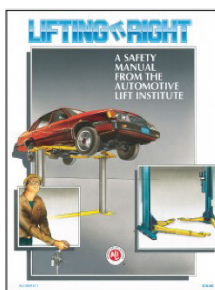

Lifting It Right. A hardcopy version of the *Lifting It Right* safety manual from the Automotive Lift Institute.



Uniform Warning Labels and Placards for 2-Posts. Labels in Mandarin, French Canadian, and Spanish are also available.



Safety Tips Card. Reminds your people of 13 key safety tips to follow daily.

Visit today and get the training and materials you need to work safely:
<http://www.autolift.org/ali-store/>.



1645 Lemonwood Drive
Santa Paula, CA 93060 USA